

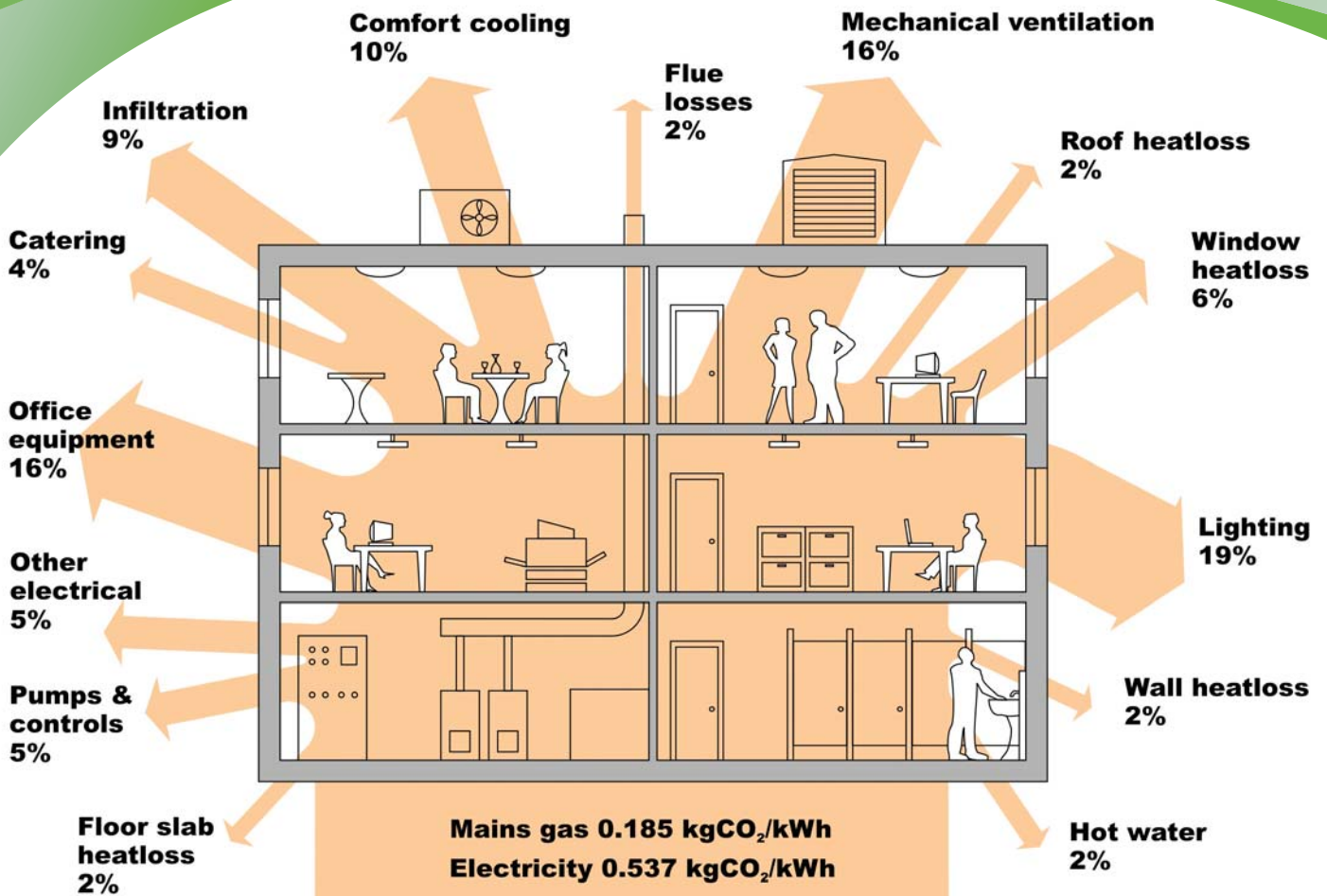

The Royal Academy  
of Engineering

# Engineering a low carbon built environment

## The discipline of Building Engineering Physics





The Royal Academy  
of Engineering

# Engineering a low carbon built environment

## The discipline of Building Engineering Physics

© The Royal Academy of Engineering

ISBN: 1-903496-51-9

January 2010

Published by  
The Royal Academy of Engineering  
3 Carlton House Terrace  
London  
SW1Y 5DG

**Copies of this report are available online at  
[www.raeng.org.uk](http://www.raeng.org.uk)**

Tel: 020 7766 0600 Fax: 020 7930 1549

**[www.raeng.org.uk](http://www.raeng.org.uk)**

Registered Charity Number: 293074

### Cover Illustration

In order to reduce carbon emissions from energy use in buildings we must first understand the balance of energy demands. Energy associated with heating, cooling, lighting and ventilating commercial buildings typically accounts for two thirds of the carbon emissions. Building engineering physics is the science of optimising the physical characteristics of buildings and their systems to balance these energy demands, exploit natural energy sources and minimise the reliance on artificial energy.

*Diagram courtesy Doug King*

### Disclaimer

This report is published by The Royal Academy of Engineering and has been endorsed by their Officers and Council. Contributions by the working group and respondents to the call for evidence are made purely in an advisory capacity. A 'peer-review' stage of quality control to the process of report production was included in the review process. The members of the working group and the consultation respondents participated in this report in an individual capacity and not as representatives of, or on behalf of, their affiliated universities, organisations or associations (where indicated in the appendices). Their participation should not be taken as endorsement by these bodies.



## Foreword

This report by Professor Doug King sets out the findings of a very significant new initiative undertaken by a group of industry sponsors under the management of The Royal Academy of Engineering. It is significant because the initiative itself concerns a branch of engineering where new skills and inspirational leadership will be needed to achieve a built environment which not only creates value, but also meets the demands of creating a sustainable future for society at large.

Put bluntly, there are not sufficient of the brightest and best entering a career in the design of buildings as a system, and the systems within a building.

An underpinning knowledge needed in that area is that of Building Engineering Physics, and this initiative is one that sets out to show how small but important changes to the way engineering is taught can inspire the brightest and best to enter that field, and to become the inspirational leaders needed for the future. A key ingredient is to overcome the lack of people who can teach at undergraduate and postgraduate level in that field. The creation and funding for four Visiting Professors in Building Engineering Physics has demonstrated what can be done.

The outcomes are already impressive. The evidence is that the initiative is already changing the way people think, and is beginning to influence teaching that helps remove boundaries between different branches of engineering, and perhaps further into architecture and planning. And crucially, that some of the brightest and best are being encouraged to seek a career in this critical area for the built environment. The report makes recommendations to build on that success. They must not be lost.

### **Richard Haryott FEng**

Chairman, The Visiting Professors in Building Engineering Physics Working Group & Chairman, The Ove Arup Foundation

January 2010

## Preface

This report presents an overview of the field of building engineering physics and identifies opportunities for developments that will benefit society as a whole, as well as employers, universities, professional engineering institutions and in particular professionals who are following careers with building engineering physics as the basis. The report makes key recommendations for Government policy, academic and industry research directions and professional development in the field to achieve the skill levels necessary to deliver mass market low carbon buildings.

This report for The Royal Academy of Engineering is a spin-off from an initiative by the Academy in association with The Ove Arup Foundation to raise the standards of education in building engineering physics for engineering undergraduates by placing visiting professors in key universities. Four Visiting Professors in Building Engineering Physics have been funded under the scheme, with the financial support of a consortium comprising the Happold Trust, Ian Ritchie Architects, Hoare Lea and DSSR. The universities that have been supported are Bath, Bristol, Cambridge and Sheffield.

In addition to reviewing the field of building engineering physics, this report showcases the achievements of the Visiting Professors in their teaching initiatives at the respective universities and the importance of this work to society through examples of their built works.

Part 1 examines the current state of education and practice in building engineering physics and highlights the needs for support and development necessary within the field. Part 2 highlights the achievements of the Visiting Professors in Building Engineering Physics and their students at each of the host universities. Part 3 demonstrates the impact that the application of building engineering physics can have on buildings and on society with case studies from the Visiting Professors' professional practices.

### **Acknowledgements:**

The content and direction for this report were determined by a workshop of the Visiting Professors and academic sponsors held in July 2009:

Professor Peter Bull, Visiting Professor, University of Bristol

Dr Buick Davidson, University of Sheffield

Professor Patrick Godfrey FEng, University of Bristol

Professor Bernard Johnston, Visiting Professor, University of Sheffield

Professor Doug King, Visiting Professor, University of Bath

Professor Steve Sharples, University of Sheffield

Professor Randall Thomas, Visiting Professor, University of Cambridge

The teaching case studies were submitted by the staff and students of:

University of Bath, Department of Architecture & Civil Engineering

University of Bristol, Faculty of Engineering

University of Cambridge, Department of Engineering

University of Sheffield, Department of Civil & Structural Engineering

The building case studies were provided by the Visiting Professors' practices:

Arup

Cundall Johnston & Partners LLP

King Shaw Associates

Max Fordham LLP

The report could not have been produced without the support and guidance of Eur Ing Ian Bowbrick at The Royal Academy of Engineering

## Contents

<b>Foreword</b>	3
<b>Preface</b>	4
<b>Executive summary</b>	6
<b>Part 1 Building Engineering Physics – the discipline</b>	8
<b>The current state</b>	8
Definition	8
Principal aspects	8
Development	10
Importance	11
Current practice	12
Current education	13
Visiting Professors in Building Engineering Physics	15
<b>Future needs</b>	16
Consistency	16
Education	16
Research	18
A systemic approach	20
Career recognition	21
Public engagement	21
Leadership	22
<b>Recommendations</b>	23
To Government	23
To the Engineering and Physical Sciences Research Council	23
To the professional engineering institutions	24
To the Association for Consultancy and Engineering	25
To the universities	25
The role of The Royal Academy of Engineering	26
<b>Part 2 Building Engineering Physics – teaching case studies</b>	28
Introduction	28
University of Sheffield, Department of Civil and Structural Engineering	28
University of Bath, Department of Architecture and Civil Engineering	31
University of Cambridge, Department of Engineering	33
University of Bristol, Faculty of Engineering	36
<b>Part 3 Building Engineering Physics – practice case studies</b>	40
Introduction	40
The BRE Environmental Building	41
Eden Court Arts Centre	43
The Innovate Green Office	45
Bristol Schools PFI	47
<b>References</b>	49

## Executive Summary

The need for professionals in the construction industry to be well versed in building engineering physics has never been higher with the global concerns to address the sustainability of the built environment. Building engineering physics is a key scientific discipline, the understanding of which allows designers to manipulate the thermal and environmental characteristics of buildings to achieve performance criteria without necessarily relying on energy consuming building services installations.

Building engineering physics, along with other aspects of building science, is taught as a minor part of a limited number of engineering degree courses in the United Kingdom. In other parts of the world building science is afforded greater significance in both education and industry. It is apparent that countries such as the Netherlands, with well established university teaching and research in building sciences, lead the UK in terms of delivering low carbon buildings.

Few people in the UK built environment field even recognise the importance of building engineering physics, let alone know how to apply the principles in the design of buildings. Building projects are traditionally led by architects, not engineers, but building energy performance hardly features in architectural education. This lack of essential knowledge to inform strategic design decisions has led to the perpetuation of an experimental approach to building performance, rather than an approach based on synthesis, rigorous analysis, testing and measurement of the outcome.



**In the 20<sup>th</sup> Century many buildings became totally dependent on fossil fuel energy to make them habitable. In the 21<sup>st</sup> Century buildings must be designed to function with much lower levels of energy dependency.**

The life spans of buildings are long and it may take a number of years for performance issues to come to light, by which time the original designers have long moved on and the opportunity to learn from experience is lost. Further, the competitive and adversarial nature of UK construction inhibits the dissemination of building performance information. Thus, the construction industry in 2010 is generally still delivering buildings that are little better in real performance terms than they were in the 1990s.

The UK goal now is to achieve 80% reduction in carbon emissions by 2050. Yet buildings presently account for some 45% of carbon emissions and it has been estimated that 80% of the buildings that we will be occupying in 2050 have already been built. The scale of the challenge in reducing fossil fuel dependency in the built environment is vast and will require both effective policy and a dramatic increase in skills and awareness amongst the construction professions.

The rapid pace of change in the regulation of building energy performance has already created tremendous problems for the construction industry and the proposed acceleration of regulatory change towards zero carbon new buildings by 2020 will only widen the gulf between ambitious Government policy and the ability of the industry to deliver.

The need for a radical overhaul in education and practice in the construction industry is urgent and undeniable. The changes necessary to achieve sustainable development in our built environment will be far reaching into areas of policy, finance, procurement practice and management. However, unless we equip the industry with the fundamental skills that will allow it to design, model and construct genuinely efficient buildings, then the transition to a low carbon economy simply will not happen.

Government must prioritise engineering and design education and skills development to deliver the manifold increase in building engineering physics professionals vital to the achievement of our national policy objectives. Government must also establish the benchmark for practice in the



**Research has demonstrated that buildings such as the Innovate Green Office by RIO Architects with King Shaw Associates, which combine good architecture with environmental design, can result in significant increases in occupant satisfaction and productivity, reduced absenteeism and turnover of personnel.**

construction industry nationally, by setting and enforcing carbon performance targets linked to financial outcomes for all procurement within the government estate and publicly funded projects and, further, by publishing the design criteria and performance data for the benefit of future designs.

The engineering profession must adapt to the new low carbon paradigm well ahead of society as a whole in order to provide the necessary leadership in design and the direction of policy. The professional engineering institutions and trade associations must all recognise a multi-disciplinary, problem solving approach that over-turns conventional partisan relationships and embraces a systemic approach to construction. All contributors to construction projects must be prepared to provide leadership in their area of expertise, but work with others to link knowledge across existing boundaries. The field of building engineering physics must be afforded legitimacy through the establishment of professional standards for education and development, conduct and service within the framework of the existing professional engineering institutions.

In order to attract the best engineers of each generation to one of the most urgent fields of engineering development we must embed understanding not just of the challenges, but the opportunities, within the collective consciousness of the public through the mass media. We must design a career path that is desired by young professionals, accredited by institutions and that will afford recognition and esteem. We must develop university courses that will excite and entice students to address the challenge of creating a low carbon world.

The Royal Academy of Engineering should take the lead in raising public awareness of engineering solutions to the problem of unrestrained energy consumption in buildings. Only through promoting understanding of the physical reality and the role of engineering design in the face of widespread misinformation can we hope to start society moving in the right direction to achieve the imperative of reducing our present unsustainable energy dependency.



**Buildings designed for passive environmental control and energy efficiency can develop a unique architectural language. For the BRE Environmental Office, designed by Feilden Clegg Bradley Architects with Max Fordham LLP as environmental engineer, the need to balance daylight with the use of solar gains to drive natural ventilation, whilst avoiding overheating, determines the form and articulates the south facing main façade.**

In order to support building engineering physicists in practice, we must develop new centres in universities and new funding mechanisms to support original and applied research into building energy performance. The dissemination of real world building performance information capable of being benchmarked, rather than marketing misinformation will not just inform future low carbon building designs, but also allow for the development of robust national policy. We must value and reward work by academics in broad multi-discipline fields of design and research and promote knowledge transfer to industry through partnerships and mass publication.

The universities must develop new fields of multi-discipline research in building design, engineering, energy and carbon efficiency, directed towards providing the industry with feedback on the success or otherwise of current initiatives. This will create numerous opportunities for industrial and international partnerships, supported by a wide range of new funding and revenue streams, not traditionally available to academic researchers.

Linking undergraduate teaching with research aligned with Government policy and embracing the environmental imperative will make a university education and a career in building engineering physics highly attractive to environmentally aware young people.





The use of thermal labyrinths to store heat energy, considered by many to be a recent invention, has been understood since Roman times. In the hypocaust heating system (this one at Chedworth Roman Villa) the masonry evens out fluctuations in heat input from the furnace and stays warm long after the fire has gone out. The same principle is applied today to moderating temperature fluctuations in low energy buildings. This principle of providing energy storage within buildings to deal with variable supply is essential to achieving a sustainable energy supply system with intermittent output from renewable sources.

## Part 1: Building Engineering Physics – the discipline

### The current state

#### Definition

Building engineering physics is a relatively new scientific discipline which investigates the areas of natural science that relate to the performance of buildings and their indoor and outdoor environments. The field deals principally with the flows of energy, both natural and artificial, within and through buildings. The understanding and application of building engineering physics permits the design and construction of high performance buildings; that is buildings which are comfortable and functional, yet use natural resources efficiently and minimise the environmental impacts of their construction and operation.

Building engineering physics emerged during the latter part of the 20<sup>th</sup> Century, at the interface between three disciplines: building services engineering, applied physics and building construction engineering. Building services engineering is the design of mechanical and electrical systems to maintain internal environmental conditions that enable occupants to be comfortable and achieve their maximum performance potential. Through the understanding of the science governing energy flows in buildings, applied building engineering physics complements and supports the discipline of building services engineering. However, applied building engineering physics must also consider the engineering performance of parts of the building not traditionally considered to be systems, such as the architectural form and envelope.

Building engineering physics comprises a unique mix of heat and mass transfer physics, materials science, meteorology, construction technology and human physiology necessary to solve problems in designing high performance buildings. Add to this the requirement for creative design and rigorous engineering analysis, and it can be seen that building engineering physics is quite distinct from any of the established applied science or construction engineering professions.

Building engineering physics itself is of course just a member of the family of natural sciences that contribute to the engineered performance of buildings, which includes biology, materials science, the psychology and comfort of humans.

#### Principal aspects

##### Air movement

Adequate fresh air supply is essential for the occupants of buildings, but air movement carries with it humidity, heat, pollutants, and sound. Air movement is driven by pressure differences through flow paths. Understanding the complex flow paths and dynamic pressure fields that act within buildings is essential to controlling airflow, through the building envelope, between internal zones, and via mechanical distribution systems, necessary to achieve comfortable, healthy, and energy efficient buildings.

##### Thermal performance

The provision of artificial heat within buildings is important to ensure comfort, health, and productivity of occupants. However, the control of heat flow through the building fabric is essential to minimise the energy expended in meeting these requirements. Heat flows by several mechanisms including conduction, transport by air or water and radiation. Building designs must include a range of measures, such as insulation, physical barriers and conduits,

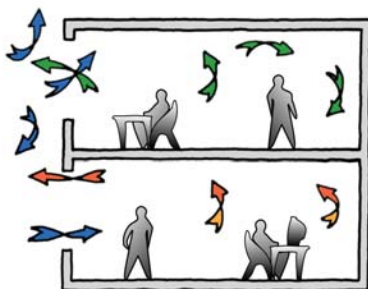

Natural ventilation is one of the most familiar aspects of energy efficient building design. In addition to draughts driven by the wind, effective ventilation can be achieved by internal heat gains or external turbulence.

to control its flow whether natural or induced such as in a radiator heating system.

### Control of moisture

Moisture is introduced into buildings from the environment, from the breath of its occupants and from the transpiration of plants. Excess moisture can result in problems of condensation, leading to the growth of mould and the development and persistence of odours. Moisture is also the primary agent of deterioration in buildings, and hence its control is essential to ensuring the durability of structures. Moisture moves by a number of mechanisms: capillary flow, vapour diffusion, air convection, and gravity flow. Modern buildings with highly controlled ventilation must include measures for controlling the build up and transport of moisture within both the interior and the fabric.

### Ambient energy

One of the largest sources of energy flow in many buildings is the sun. We are used to thinking of the sun in terms of providing light, which with proper design can avoid the need for artificial lighting in buildings for the majority of the year. In addition to light, solar heat gain through windows typically dominates the cooling demands of commercial buildings and without adequate control can lead to reliance on air conditioning. On the other hand, the same energy can also be harvested for both space and water heating in carefully designed buildings.

### Acoustics

The basic physics of sound propagation are simple, but the interaction of sound pressure waves with complex shapes and multi-layer constructions with openings, as you find in buildings, is more challenging. Controlling noise, both from the internal and external environment and from the internal mechanical and electrical services in buildings, is essential to create environments that promote aural communication and comfortable working conditions.

### Light

Light is essential for function, but simply providing sufficient illumination by electric lighting is rarely adequate for high performance buildings. Lighting design must consider source intensities, distribution, glare, colour rendering and surface modelling if we are to create stimulating high quality interior environments. Daylight is often dismissed in lighting design as being too variable to be reliable, but daylight design is essential to reduce reliance on artificial lighting.

### Climate

Climate varies throughout the world and locally depending on site characteristics. The design of high performance buildings must take account of climate variables such as wind loadings and potential for energy extraction, solar access for light and heat gains, and temperature and relative humidity variation through the seasons.

### Biology

In addition to the fundamental physical aspects of building design, anyone designing sustainable buildings also needs to have a good understanding of human physiology, particularly relating to comfort and task performance. A basic understanding of biology and ecology creates opportunities to enhance the natural environment and supplement the performance of the building through the integration of planting and landscaping. Planted roofs and shading by deciduous trees both make valuable contributions to the thermal performance of buildings.

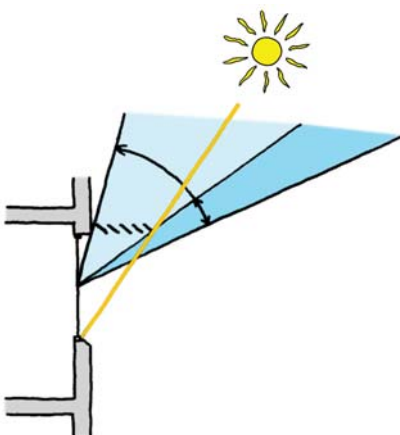

**Designing to maximise daylight throughout the year whilst minimising overheating caused by direct sunshine requires detailed analysis of the performance of the building envelope.**

## Development

Ever since humankind first sought shelter from the elements, buildings have been continuously evolving. Once the basic needs of shelter had been satisfied our ancestors refined their dwellings to control the internal environment and improve comfort. Early builders only had a limited range of materials available: wood, grass, clay, natural stone and eventually copper, lead, iron and glass. These materials were in use for centuries and reliable techniques for their use in construction developed by trial and error over many generations.

Through experience, driven by the need for economy when the primary energy source for construction, food and fuel gathering was human effort, vernacular dwellings evolved to represent the most efficient response to the climate given the local availability of resources. Any energy expended unnecessarily by humans on keeping warm meant less energy available for gathering food or for reproduction. Thus, vernacular building forms can be considered to have evolved through natural selection into the forms best suited to particular climates given the available resources.

As society became more sophisticated, so did the demands placed on buildings. The industrial revolution effectively brought an end to the period of our history where buildings developed empirically. Manufacturing technologies created new opportunities for existing materials and introduced entirely new materials to the palette available for construction.

Simultaneously, advances in science and mathematics made the calculation and prediction of structures more reliable and longer spans could be engineered without fear of failure. Energy became plentiful and cheap as abundant sources of coal, oil and natural gas were discovered and exploited, allowing industry to replace manual labour with machinery.

The result of the industrial revolution was mass building and urbanisation, creating unprecedented demands for new building types. The practice of designing buildings became as much about providing the facilities necessary for commercial and industrial organisations as about providing basic shelter and comfort.

In the early 20<sup>th</sup> Century the modern architectural movement emerged bringing new forms of building that threw away the former empirical experience, instead favouring experimentation with the new materials and structural forms that were becoming available. Many of the early examples of modernist movement showed little concern for energy consumption, comfort, or the physical parameters governing the building's performance.

Some of these experiments led to failures of the building envelope which, with hindsight and knowledge of building engineering physics, could have been predicted and avoided. Building engineering physics as a distinct branch of building engineering emerged after World War II in response to this need to predict a building's environmental performance and avoid failure. The field saw a strong increase in interest at the time of the energy crisis during the 1970s and again now as energy efficiency is once more becoming an overriding concern in the evolution of buildings.

## Importance

We are at the start of a period when the application of building engineering physics will become one of the principal drivers in the construction of new buildings. In the 21<sup>st</sup> Century buildings and their construction must evolve rapidly to meet emerging challenges. The urgent need to reduce our dependence on fossil fuels, in order to cater the demands caused by population growth and the search for better standard of living, is well understood. In addition, predicted changes in climate could result in increased demands for building systems such as air conditioning<sup>(1)</sup>, potentially coinciding with the reduced availability of cheap energy as fossil fuels pass their peak of production and go into decline<sup>(2)</sup>. In order to conserve energy and resources for the things that we really need, we will have to cut down on those that we do not. The need for sustainable buildings is more pressing than ever and this

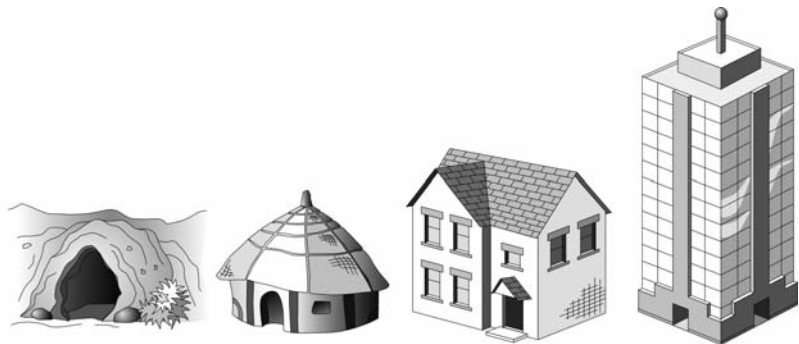

**Vernacular building types evolved in response to local availability of resources. Only since the mass exploitation of fossil fuels has humankind been free to build resource and energy inefficient buildings.**

means making real advances in energy efficiency through the application of building engineering physics. Society must avoid the zero sum approach of simply installing renewable energy generation alongside conventional, energy hungry, building designs.

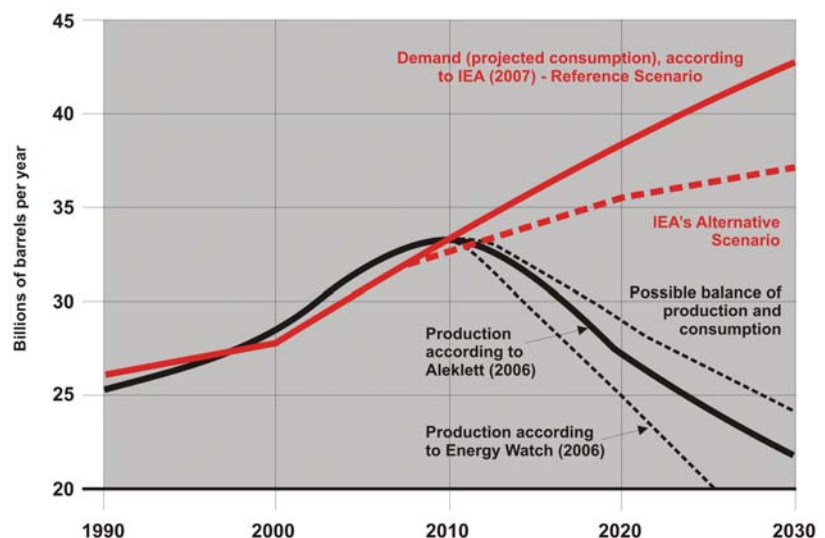

Predictions for future global demand for oil and the potential decline in production capacity indicate a possible dramatic shortfall within a decade. After Gilbert & Perl 2008<sup>(3)</sup>

In order to create new buildings, and adapt existing ones, to be fit for the 21<sup>st</sup> Century, rigorous performance analysis and energy prediction needs to gain widespread acceptance as the replacement for experimental development. In an industry where each product is essentially a prototype, and when it may take years or decades for building performance problems to come to light, we can no longer afford the luxury of experimenting with the physical form of buildings. Without integrating the rigorous performance analysis brought by building engineering physics with the architectural design and with the empirical construction knowledge embodied in the industry, we will continue to construct inefficient buildings whose energy performance falls far below that which we need to achieve.

Government set out in Building a *Greener Future*<sup>(4)</sup> that all new homes must be zero carbon from 2016. As steps to achieving this target, energy efficiency standards for new homes are to be improved, through revision of the Building Regulations, by 25% in 2010 and 44% in 2013 relative to current 2006 standards. *The Proposals for amending Part L and Part F of the Building Regulations*<sup>(5)</sup> make it clear that a similar trajectory for carbon reduction will apply to non domestic buildings.

In the UK the 2006 revision to Part L of the Building Regulations<sup>(6)</sup> in itself required a 25% reduction in carbon emissions over the previous standard. The construction industry, and in particular the domestic sector, presently struggles to provide even this relatively modest improvement over what has been common practice for many years.

## Current practice

The practice of applied building engineering physics in the construction industry may be described by any number of names: building analysis, environmental engineering, sustainable design or low carbon consultancy to name but a few. Substantial growth in the market for such services has been driven in recent years by the introduction of regulations, requiring the calculation of carbon emissions to demonstrate compliance, principally the Energy Performance of Buildings Directive (EPBD)<sup>(7)</sup>.

The discipline that traditionally deals with energy conservation and building performance, building services engineering, has risen to the challenge to some extent, but engineers in this field typically have had little engagement with architectural or structural design and therefore often lack understanding of the total construction. Architects and structural engineers who understand the construction may not have encountered energy conservation issues. This position is further exacerbated by the severe engineering skills shortage in the construction industry generally.

This position has led to a new type of professional, a sustainability consultant or code assessor, who understands the regulations in detail and can use software to generate the necessary certification for new buildings. The field has no recognised codes of practice or professional standards and work is often undertaken by consultants from wide ranging backgrounds who may not be conversant with the principles of building engineering physics, or even engineering. This lack of consistency results in enormous variations in the standard of service provided by practitioners.

Thus the design of buildings, traditionally disconnected between the disciplines, has become even more fragmented. A design team may often now comprise architect, structural engineer, building services engineer,

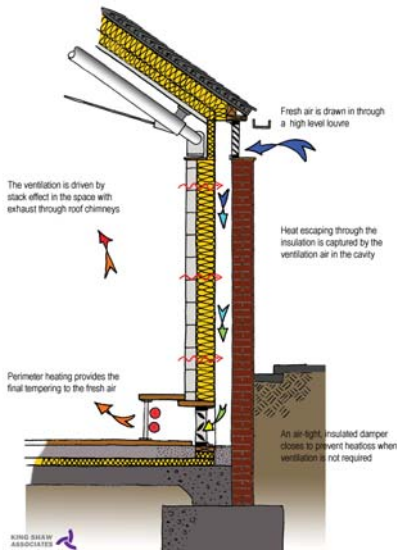

**In this natural ventilation system at the Hampton Court Palace Education Centre, the building envelope has been engineered to achieve heat recovery by capturing the fabric heat-loss to temper fresh air.**  
 Courtesy King Shaw Associates

sustainability consultant and code assessor all vying to be seen as the champion of sustainability. However, these teams often fail to communicate and co-operate to make the key strategic decisions that will reduce demand on mechanical and electrical solutions for comfort and climate control.

Construction clients are increasingly specifying performance standards for buildings, such as a target energy performance rating, a specific rating under the Building Research Establishment Environmental Assessment Method (BREEAM) or other international standard such as Leadership in Energy and Environmental Design (LEED). However, the industry lacks sufficient information, guidance and mechanisms to design and construct buildings to achieve such targets.

The process usually adopted is therefore to design a building following traditional methods, simulate the performance of the building design using software and then try to address the excessive demands on energy and other shortcomings by adding expensive renewable energy technologies. This leads to unnecessarily expensive buildings and often a failure to meet the original target as the final expense of doing so would be too great.

Whilst this failing is prevalent throughout the construction industry it has been highlighted by the National Audit Office in relation to the Government estate, which since 2002 has failed to achieve environmental performance targets on new building procurement in some 80% of cases <sup>(8)</sup>. Without an equivalent to the National Audit Office to police private sector construction there is no data available, but it would be reasonable to suppose that the scale of the failure to achieve targets is of similar, or greater, magnitude.

As a result, there is a widespread view that energy efficient buildings are more expensive to construct than conventional, established designs. However a range of studies indicate that buildings aiming for a high environmental performance are no more or less expensive than conventional buildings <sup>(9)(10)</sup>.

## Current education

Building engineering physics is too narrow a field to be taught as a degree subject at undergraduate level, but the principles are included to some extent in a range of construction engineering degrees. The broader subject of building science used to be offered at degree level by a number of UK universities, including Sheffield, but these courses have gradually been subsumed into general engineering degrees. Overseas there are a number of universities that still specialise in building science, including the Technical University of Delft and University of California, Berkeley. It is notable that these universities are in parts of the world where the levels of environmental awareness are much greater than in the UK.

Building science and building engineering physics is relevant in the education of anyone who will design or specify the environmental performance of buildings. The courses on offer in the UK that teach elements of building engineering physics are generally building services engineering and some universities offer general construction engineering; covering aspects of building engineering physics and building services engineering alongside structural engineering, on courses described as architectural engineering.

The Chartered Institute of Building Services Engineers (CIBSE) presently accredits only 16 undergraduate degrees as suitable for Chartered Engineer in building services engineering, from 12 institutions, including the Open

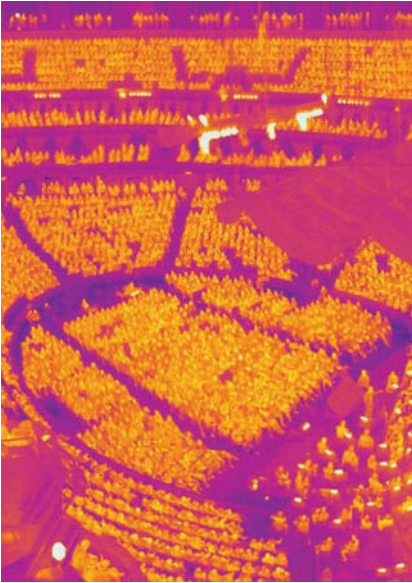

**Engineering low energy buildings requires a detailed understanding of the natural forces at play. This thermal image of the Royal Albert Hall indicates that the heat from audience bodies dominates the thermal environment.**  
Courtesy King Shaw Associates

University<sup>(11)</sup>. Of these degrees, only three courses of full time study and one from the Open University lead to the award of MEng and so satisfy the requirements of the Engineering Council for Chartered Engineer without additional studies.

This lack of sufficient courses in Building Services Engineering has arisen partly from lack of demand from potential students to engage in a subject that did not catch their imagination. Such lack of demand led, for instance, to the demise of CIBSE accredited course in building services engineering at the University of Bath. Such courses were, and still are not, seen as a gateway to a challenging, rewarding engineering career vital to the 21<sup>st</sup> Century world.

In contrast the Joint Board of Moderators (JBM), for civil, structural and highway engineering, currently accredits courses from around 50 universities, with over 100 degree courses at MEng alone<sup>(12)</sup>.

The guidelines for accreditation of undergraduate degrees by CIBSE require that fundamentals of engineering and building engineering physics comprise 25% of the taught content, the remainder being specific building services engineering or general professional topics. The JBM sets no requirement for building engineering physics and review of the accredited courses indicates that only around 10 universities offer any identifiable building engineering physics content, but this can be as little as one unit.

Thus, the opportunities for school leavers to gain any appreciable education in building engineering physics are extremely limited, with only around 20% of universities providing any teaching in the field.

At the postgraduate level the profession is somewhat better provided for with some 30 Masters degrees accredited by CIBSE for the additional studies required on top of a Bachelors degree to achieve chartered engineer qualification. However a number of these courses are designed as conversion degrees for students from a wide range of backgrounds and therefore can lack engineering rigour.



**The Queens Building for the School of Engineering and Manufacture at De Montfort University, by Short Ford Architects with Max Fordham LLP as environmental engineer, is a masterpiece of legible design. Designed to be naturally ventilated and daylit the results are explicit in the architecture. The engineering workshops are lit with roof lanterns whilst the tall chimneys induce sufficient draught to naturally ventilate the lecture theatres.**

## Visiting Professors in Building Engineering Physics

In 2001 a report commissioned by The Ove Arup Foundation *Attracting The Best And Brightest: Broadening The Appeal Of Engineering Education*<sup>(13)</sup> identified a mismatch between the emphasis in undergraduate engineering courses on civil, electrical and mechanical engineering and the majority of construction output that takes place in the building sector. This work concluded that the field of building services engineering was significantly under-represented in education and in the numbers of high calibre candidates entering the profession.

The report made specific suggestions as to how additional course elements could be integrated with current civil and mechanical engineering curricula by re-configuring them in small but important ways. The aim in so doing would be to encourage students to develop an interest and potentially a worthwhile career in the crucial and demanding areas of building engineering physics and building services engineering.

In 2004, The Ove Arup Foundation in conjunction with The Royal Academy of Engineering launched an initiative whereby university engineering departments would be invited to bid for funding for a Visiting Professorship in Building Engineering Physics. The idea was that by strengthening those parts of the curriculum relating to such matters as building engineering physics, building services engineering, whole life costing and energy, undergraduates could be attracted to meet these challenges. They would then emerge with a broadened academic base likely to appeal to employers keen to recruit people with degrees immediately relevant to their changing needs.

A number of Universities were invited to bid for funding. They had to demonstrate not only that they could secure the services of a highly qualified practitioner in the field, but also how they would use the position to enhance interdisciplinary teaching and collaboration within and beyond the faculty or department concerned.

Initially three posts, at Bristol, Cambridge and Sheffield, were funded for four years from the start of the 2006/07 academic year. Funding for these posts was provided by a partnership consisting of The Ove Arup Foundation and The Royal Academy of Engineering and from The Happold Trust, Ian Ritchie Architects, DSSR and Hoare Lea. The Royal Academy of Engineering agreed to administer the scheme. In 2008 a fourth appointment was made at the University of Bath.





**The use of on-site renewable energy generation has become highly fashionable, but its contribution to the energy demands of conventionally designed buildings is negligible. The priority must be to engineer buildings to minimise energy demands in the first place.**

## Future needs

### Consistency

The application of building engineering physics to the solution of real problems of designing for low carbon buildings can be extremely hit and miss. There is no universally accepted scope of services for the provision of building engineering physics analysis and design in the way that there is for the building services engineer, as set out by the Association for Consultancy and Engineering (ACE) in their Conditions of Engagement <sup>(14)</sup> or the architect as contained in the Royal Institute of British Architects (RIBA) in Standard Form of Agreement <sup>(15)</sup>. In fact, it is now common in the UK for confusion to arise over responsibility for the specification of thermal insulation, building air tightness, solar shading devices and window performance.

Traditionally the performance of a building envelope has been specified by the architect and clearly this does not form part of the building services installations. However, with the increasing need to consider the thermal elements of the construction as part of the overall environmental control system, it has become common for the architect to look to the building services engineer to define their performance and design detailing, an area in which building services engineers traditionally have little training.

Similarly in the UK the architect still holds the responsibility for demonstrating that the building complies with Part L of the Building Regulations. However, now that Part L requires detailed analysis of the building carbon emissions this involves detailed knowledge of the building services systems in addition to the characteristics of the construction. These calculations are generally undertaken by the building services engineer, who may not be fully conversant with the construction details, or by a third party sustainability consultant, who may only have scant knowledge of the design at all.

Construction clients and the industry in general need clear guidance on which parties in the design team should bear responsibility for which aspects of the design. In order to achieve verifiable low carbon design this may require the re-allocation of design responsibilities on the basis of building performance rather than on the basis of components. Thus, rather than the architect being responsible for the specification of the windows, the architect would become responsible for the construction detailing and weather-proofness of the window assembly, whilst the building engineering physicist on the team, whether architect, building services engineer or sustainability consultant, would be responsible for specifying the thermal, acoustic and light transmission characteristics. The division of responsibilities needs to be clearly indicated in the appointment documents for all the parties involved in construction projects.

## Education

The current trajectory for carbon reductions embodied in UK Government policy and the plans for Part L of the Building Regulations will require a dramatic up-skilling of professionals in the construction sector. Yet, the skills that will be essential to delivering this scale of reduction are simply not taught at present in the majority of universities. Even when the fundamental principles of building engineering physics are taught, there is often insufficient exploration of the application to low carbon buildings to attract students to take up the challenge.

Whilst some of the best engineering courses do emphasise project work to expose students to real life problems, it has traditionally been the preserve of the universities to teach theory and leave the application to industry. Nevertheless, the rate of change required in the construction industry calls for a radical transformation in building engineering physics education. With a four year MEng being the norm and planned revisions of the Building Regulations at three to four year intervals, the education of engineering graduates is likely to be out of date even before leaving university.

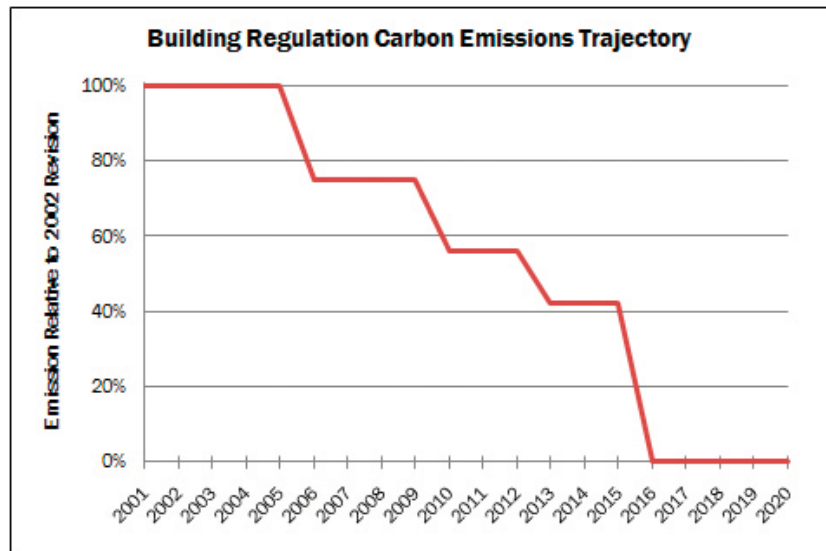

**The building industry has never been set targets for energy efficiency or carbon reductions before. Now, in the domestic sector, it faces progressive changes in regulation to carbon neutral over a period of just 10 years.**

University courses take time to design, approve and implement, and rely on there being sufficient authoritative reference material on a subject. The lack of reference material in the industry, the focus of academic research on narrow subject areas and in some cases the reliance on practitioner teaching means that, on the whole, the level of energy conservation design being taught is, like the majority of the industry, still only relevant to the 2002 Building Regulations.

Many precedents and case studies presently used in undergraduate teaching are significantly out of date, as recent projects have not yet been evaluated to the same extent as those pre-dating the recent changes in regulations. Further, many precedents are drawn from 'Practice Books' written by architectural or engineering practices to promote their work. In the absence of rigorous post occupancy evaluation (POE), these may not present information about the real performance of the designs. In some cases, the reliance on teaching by practitioners from industry, who themselves have to work hard to keep up-to-date with new developments, can mean that there is often too little critical examination of these issues.

Thus, by the time that the 2009 undergraduate intake to built environment engineering courses graduate in 2013, the industry will be required to deliver a 58% reduction in carbon emissions against the design practices and benchmarks that they will have likely been taught during their university education. Furthermore, whilst these graduates are simply trying to adjust to this new requirement, within three years they will have to deliver domestic buildings which are zero carbon.

The lack of teaching building engineering physics impacts throughout the continuing education and development of professionals. Engineers presently in

the middle of their professional careers will have started in the industry at a time when carbon did not feature in policy and the architect simply installed insulation to the standard details in order to comply with Part L of the building regulations. In 2004 43% of professional engineering practices in the construction sector indicated that they had experienced skills and competence gaps among their professional engineering staff<sup>(16)</sup>. Now, with the increasingly rapid pace of change, it is likely that the gulf between policy and available industry resource will grow ever wider.

## Research



**The demand for energy in buildings continues to rise through the increased use of IT and labour saving devices. These increasing demands often far outweigh the energy savings that can be made by energy efficient building design.**

The most pressing needs in the construction industry today are for reliable information on the actual energy and carbon performance of recently constructed or refurbished buildings. This information is essential for the establishment of benchmarks and standards, for the validation of new designs and techniques, for the development of robust national policy and for the development of up to date and authoritative teaching materials.

The Energy Efficiently Best Practice Programme (EEBPP) was the UK Government's principal energy efficiency information, advice and research programme for organisations in the public and private sectors. Established in 1989 and run by the Building Research Establishment (BRE), it maintained the biggest library of independent information on energy efficiency in the UK. Since the transfer of the EEBPP to the Carbon Trust in 2002, the wealth of information, amassed over many years has gradually become unavailable and is now largely out of print.

The programme for Post-Occupancy Review of Buildings and their Engineering (Probe)<sup>(17)</sup> was a research project which ran from 1995-2002 under the Partners in Innovation scheme. The work was undertaken by Energy for Sustainable Development, William Bordass Associates, Building Use Studies and Target Energy Services, jointly funded by the UK Government and The Builder Group, publishers of Building Services Journal. Probe investigated some 20 new buildings of the period and published the results of POE in the Building Services Journal. There has been no popular publication of building performance studies since.

There are presently no other freely available central resources on energy efficiency best practice. In order to learn from experience and move rapidly to the new low carbon paradigm, the construction industry needs a national database of new building POEs and carbon performance data.

Other industry based membership organisations, such as Construction Industry Research & Information Association (CIRIA) and the Building Services Research & Information Association (BSRIA), whilst performing part of this role, are insufficiently funded to meet the demands of the entire construction industry.

The research essential to revolutionising the construction industry must be provided by independent and academic researchers, collaborating across a broad spectrum of construction disciplines. This effort cannot be left to the industry, as its competitive and adversarial nature inhibits disclosure of both successes and failures by the parties involved. Successes are jealously guarded by their innovators in order to gain marginal commercial advantage and failures are similarly concealed in order to avoid commercial disadvantage. Thus, only the mediocre is subject to public scrutiny and thus becomes the benchmark for practice and for teaching.

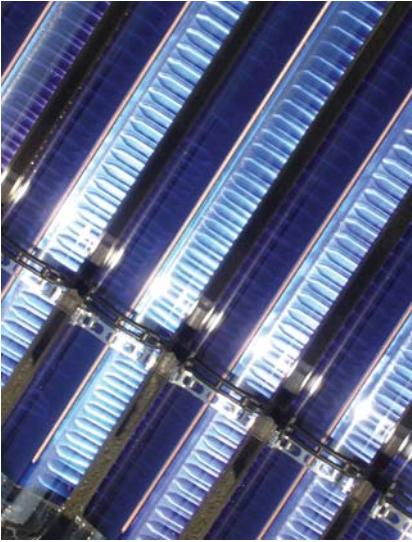

**Integrating renewable energy into buildings can impact on the architectural form and space planning, façade design and building services systems; it cannot be achieved without collaboration. Solar thermal collectors for heating water are, for the time-being, one of the few economically viable technologies with reliable, simple application.**

There is also a need for fundamental research in many areas relating to energy supply and carbon reductions, not just in the area of building engineering physics, which is inadequately supported at present due to the established funding mechanisms. In order to qualify for funding from bodies, such as the Carbon Trust, researchers must be able to demonstrate a route to market, limiting the opportunities for more fundamental research with a broad range of application not linked to one industrial partner<sup>(18)</sup>. Thus, we are failing to develop potentially beneficial lines of research due to restrictions in the funding criteria.

It is important that we find new and more agile means of supporting both fundamental research and transfer of the knowledge to industry that do not rely on the previously established frameworks.

The rate of change required to achieve our national objectives will not allow for the luxury of selective research and publication, where it may take years for relevant information to penetrate education and then industry practice. In order to reach the intended audience, the dissemination of research, particularly building performance analysis, must include professional and popular journals, new textbooks and the popular media in addition to refereed journals. The value of such works by academics must be recognised and rewarded as highly as journal publication, which until now has been the primary metric used to assess research quality<sup>(19)</sup>.

The Engineering Doctorate (EngD) offers a means for delivering practical outcomes from research partnership between Industry and Academia. There are opportunities to promote the use of EngDs to progress some of the research needed, albeit this is more likely to be at the application level than that of the more fundamental research. Nevertheless it should help to accelerate the transfer of theory into practice.



**The Westmill Co-operative community wind farm may herald the future of low carbon electricity generation. However the variable nature of renewable electricity will need buildings that are resilient to fluctuations in supply in order to balance the system. Buildings designed with thermal energy storage and electric heat pumps can provide such resilience, but require a fundamentally different approach to conventional buildings.**

## A systemic approach

The delivery of mass market low environmental impact buildings requires a new approach to design and construction.

The design and engineering of buildings and their systems is becoming ever more complex. Even historically, individuals could not encompass the entire scope of engineering required for a project; hence the traditional division of disciplines between civil, structural and building services engineering. Now, in order to keep up with the rate of development of new technologies, even within the disciplines, it is necessary to further specialise. Thus, we see emerging specialisms in areas such as plastics and composites, renewable energy, communications and building management systems (BMS).

These changes in the industry have fragmented the engineering input to a project to such an extent it is rare that any individual or organisation can perceive the whole picture. The energy performance of buildings can be influenced by many diverse factors from the location and construction to the use of information technology. However, without anyone holding an overview, the engineering solutions can lack coherence and the full benefits of a holistic approach are not realised. In order to assimilate sustainability into our approach to construction projects we must re-integrate all the engineering disciplines to deliver holistic solutions. By avoiding over-engineering, identifying component solutions that complement each other and designing elements to deliver multiple benefits, such as using the concrete building frame for thermal storage, we can achieve the goals of both economic and environmental sustainability.

The approach to systems engineering recognises that complex products, such as buildings, require many interdependent systems to function in harmony. For example, in buildings the heating and ventilation are interdependent systems and both are also governed by the thermal performance and air-tightness of the building envelop. Furthermore, the interaction of human occupants and internal processes with the building systems can fundamentally alter the overall performance.

The systems approach focuses on defining the overall performance requirements at an early stage, before proceeding with design synthesis and validation of the component systems while still considering their contribution to the solution of the complete problem.

The practising building engineering physicist already has to operate across the established frameworks of architecture, structure, construction and building services. The form, frame, aesthetics and choice of materials will all influence the final energy performance of the building as much as the services installations. At times conflicting functional, structural and performance requirements will make it difficult to find an optimal solution and the building engineering physicist has to exercise engineering judgment to achieve a satisfactory compromise.

Formally integrating a systems engineering approach with the fundamentals of building engineering physics and building services engineering would therefore significantly strengthen the ability of practitioners to influence the design of a wide palette of components and solutions for the benefit of the ultimate project performance.

## Career recognition

At present there is no recognised profession of building engineering physics with associated standards for education, conduct and professional development. Building engineering physics does not fall within the sphere of any of the professional engineering institutions (PEIs) as they are presently drawn, and there is no opportunity to qualify as a chartered engineer in the field of building engineering physics. In an industry that positively discriminates in favour of chartered status, budding building engineering physicists may be discouraged from developing their careers in that direction, when the only options of becoming chartered are as a structural, civil or building services engineer.

In order to entice the brightest engineers to pursue a career in building engineering physics or buildings services engineering, it must be demonstrable that the profession offers the respect and kudos afforded to mechanical, structural or civil engineering. There is no reason why the PEIs working together should not resolve this situation. The practice of applied building engineering physics fits directly with the UK Standard for Professional Engineering Competence (UK SPEC)<sup>(20)</sup>.

## Public engagement

The Royal Academy of Engineering report *Educating Engineers for the 21<sup>st</sup> Century*<sup>(21)</sup> identifies that engaging young people with engineering is vital to the future health of the nation and this is already the topic of much debate in the profession. However, the shortfall in engineers to design low carbon infrastructure is not simply about economic success, it is fundamental to maintaining our very way of life in the face of diminishing resources worldwide.

In order to recruit the next generation of engineers and building engineers physicists essential to deliver sustainable development, we must educate the general population and, in particular, parents and teachers who will influence career choices. However, in order to engage people with sustainable engineering we must also establish the link between sustainable development and engineering. Unfortunately there is very little accessible, yet reliable material available to science and engineering teachers.

It may however prove easier to change perceptions amongst young people if we can reach them through extensions of existing behaviours such as computer gaming. This is where building engineering physics can perhaps learn from the mainstream physics community, where interactive exploration tools have long been a part of the culture of learning in the physical sciences.

The current Technology Strategy Board (TSB) funded project Design & Decision Tools<sup>(22)</sup> may very well generate material that could lead to such interactive tools and games. The purpose of the project is to develop simple analysis tools that can guide small practitioners through the key design decisions for new building developments and allow the impacts on carbon performance to be assessed. This is very much at the level of engagement that could be used as an education tool in schools and could be adapted into an accessible game for the public.

Most importantly these games must be designed not by engineers, but by creative professionals familiar with public engagement. Although the validation of the science and engineering content will be vital to ensure accuracy and consistency with the media messages, the issues must be interpreted by



**Phun is a free game, effectively a 2D physics sandbox where you can explore the principles of physics. The playful synergy of science and art is novel, and makes Phun as educational as it is entertaining. It is a fantastic toy for children to appreciate physics in open ended gameplay with rich creative and artistic freedom. Phun's creator estimates that within 10 months of its initial release on the internet, it had been installed on over 300,000 school computers.  
[www.phunland.com](http://www.phunland.com)**

designers familiar with presenting complex concepts to the general public and the software developed by professionals with a track record of successful computer game development.

## Leadership

Solving the fossil fuel energy crisis is vital to our future welfare and the engineering profession must take ownership and leadership of it. If we are to mitigate climate change and secure our future energy supplies with the minimum social and economic impacts, we must fundamentally change the public perception of the issues.

Popularisation of green architecture in the media without a corresponding voice for sustainable engineering design has led to widespread misunderstanding of the issues amongst the general public.

Architects have often taken the credit for spectacular feats of structural engineering, but if we are to solve the energy crisis and deliver a sustainable future for society, we must ensure that there is proper balance in the portrayal of sustainable construction and development. There must be no doubt in the public mind that engineers and building engineering physicists will play a vital role alongside the architects in developing the future of our society. We need young people, their parents and teachers to understand that engineering is a profession that will allow them to make a substantial difference to the world around them.

It is vital that we raise the profile of sustainable engineered solutions, over the marketing hype that often passes for environmental responsibility in the media. Producing accurate and impartial analysis and case studies of buildings, which will become the teaching material for future students is far too important to be left to commercial interests. The engineering profession must therefore become much more visible and articulate in the media and be able to engage in debate about sustainable development.



**Significant advances in energy efficient design, such as the Millennium Sainsbury's at Greenwich, can only be achieved by close collaboration between the architects and engineers from the outset of a project. By the time the building design has been sketched the major opportunities for energy conservation will have either been captured or lost forever.**

## Recommendations

### To Government

1. Government should commission and finance a follow up report to establish the numbers of new building engineering physicists that will be required to enter the profession over the next decade both at Chartered Engineer and Engineering Technician level. These building engineering physicists will be necessary not only to design and deliver the low carbon buildings that will be required under the future revisions of the building regulations, but also to assess the compliance of such buildings for building control.
2. Government should make education and research in building engineering physics a priority in policy for climate change mitigation and energy security. Without urgent action by Government and substantial financial support for education and re-training, the construction industry will be unable to make the necessary step change in carbon emissions performance.
3. Government should consider the opportunities to incentivise training and even re-education in the field of building engineering physics for professionals in the construction industry. At a time when we need to increase the professional skills necessary to deliver low carbon buildings the industry is losing swathes of experienced professionals through redundancy.
4. Government should provide new funding for an extension of the programme Post-Occupancy Review of Buildings and their Engineering (Probe), which was formerly funded under the Partners in Innovation Programme (PII). Probe provided the industry with essential feedback on the real performance of innovative buildings, information which has been missing since 2002.
5. Government should lead by example and immediately commission post occupancy evaluation (POE) of all new buildings in the Government estate constructed since the introduction of the 2006 revision of the Building Regulations, to compare with their target performance criteria. This will quickly establish a useful national database of design techniques and carbon performance.
6. Government should make it policy that the procurement of all new buildings funded with public money must include extended post occupancy commissioning and a full POE of performance with publication of the results to a national database.

### To the Engineering and Physical Sciences Research Council

1. The construction industry needs a national centre of excellence in Building Engineering Physics. The 'Carbon Reduction Best Practice Programme' should be established as a matter of urgency to organise research, collate and particularly to disseminate authoritative information on low carbon building design. This centre should be hosted by one of the UK's leading universities and should be funded directly by a UK funding agency, similar to the UK Climate Impacts Programme. This centre should be based in an academic institution both to give it authority and to ensure that the information is commercially unbiased and free to all.



2. The centre should establish close links with industry by engaging research fellows directly from construction and consultancy companies. These research fellows will be pursuing an industrial rather than academic career, and so will be motivated by stimulating innovation in the industry, which will establish research directions that will be of immediate, practical use. Furthermore, providing the opportunity to pursue research interests within an industry career will provide much greater appeal to the brightest students in future generations. This is an ideal opportunity to both promote the Engineering Doctorates to the construction industry and to provide the support that the industry needs.
3. There is a need for genuine blue skies research in low carbon and alternative energy technologies appropriate to buildings, an area in which the construction industry has typically not engaged being focussed on commercial returns. Existing research funding from bodies like the Carbon Trust is also geared to short term returns and so does not encourage research with no obvious outcome.

### **To the professional engineering institutions**

1. The term Building Services Engineering does not convey the importance of the field nor does it adequately describe all the actual work of practitioners. Finding appropriate terminology to describe it will be fundamental to attracting the brightest and the best into the most critical field of engineering that exists today. The emerging field of low carbon engineering must be afforded the respect and status that will attract the best engineers of each new generation.
2. One of the established institutions must adopt the field of building science/building engineering physics/low carbon engineering, nurture and promote it, in order to provide recognisable status, career progression, and appropriate codes of practice, education and continuing training for professional building engineering physicists. Guidance should highlight the types of work in the field appropriate to the levels of registration. It must be possible to become a chartered engineer whilst engaged in the field of building engineering physics.
3. The Chartered Institute of Building Services Engineers (CIBSE) needs urgently to embrace all aspects of low carbon building design, not just energy efficient design of mechanical and electrical systems. When CIBSE champions these issues, of which building services engineering is a subset, it will justifiably be a leading professional engineering institution in the sustainability debate.
4. The professional engineering institutions, Royal Institute of British Architects and the Royal Institute of Chartered Surveyors are all pursuing strategies for sustainable development independently. This represents a tremendous duplication of effort and a lost opportunity for wider dissemination of ideas. They need to establish a cross industry forum for developing strategy for a sustainable built environment.

**To the Association for Consultancy and Engineering**

1. The industry needs a properly drawn and widely accepted scope of services for the provision of building engineering physics and environmental performance analysis on building projects. This needs to be identified as a service separate from building services engineering and accompanied with guidance on appropriate scope of services and fee scales. This scope of services should be integrated with both the Royal Institute of British Architects scheme of works and the existing Association for Consultant Engineering agreements.

**To the universities**

1. Building engineering physics is an engineering discipline for the future of the built environment. The subject, and particularly its application to the design of low carbon buildings, needs to become a core part of all civil, structural and architectural degree courses, not just building services engineering courses.
2. Systems engineering is becoming an increasingly important part of designing low carbon buildings. The principles of systems engineering and of multi-discipline design need to be enshrined as the core of teaching building services, civil, and structural engineering.
3. Research in the field of building engineering physics will become increasingly important and can attract funding from industry and other Government sources such as the Carbon Trust and the Technology Strategy Board in addition to the conventional research councils.
4. There is a great deal to be learned from studying low carbon design in other countries worldwide. This represents tremendous opportunities for new fields of research and international collaborations, which are well supported by The Royal Academy of Engineering.
5. The interfaces between buildings and urban environments and infrastructures will play an increasingly important role in the future and yet this is a field that is poorly researched and understood at present. Sustainable urban planning and design represents a rich field for research opportunities.

### **The role of The Royal Academy of Engineering**

1. The Royal Academy of Engineering could play a significant role in raising public awareness of sustainable engineering development. With the expertise of its Fellows, the Academy should engage with the environmental debate in the media to become the authoritative voice on the physical and engineering substance behind the issues of the moment. We would encourage The Academy aims to expand its work in reviewing the media and respond to articles and news features to support worthwhile initiatives, but most importantly to refute unfounded claims. The Academy aims to become a thought leader on issues of sustainable development.
2. The Royal Academy of Engineering aims to extend its present programme of engagement activities for young people to include the development of computer games and interactive online tools that will allow the exploration of issues around sustainable development first hand. It is not possible to experiment with real buildings and urban designs, but computer games like SimCity, which allowed players to experience the successes and failures of urban design and socio-engineering, achieved cult status. A similar game of playful experimentation could be used to explore issues about sustainable renewable energy, urban planning and building design, both to excite and educate the public.
3. It has been suggested that The Royal Academy of Engineering co-ordinate the efforts of the professional engineering institutions, and possibly even the Royal Institute of British Architects, in promoting sustainable development. Much of the valuable work being undertaken by individual institutions is not disseminated widely enough and conversely there is much duplication of effort.
4. The Royal Academy of Engineering aims to promote its wide ranging schemes for supporting international research efforts as a means for academics and practitioners to study the application of low carbon design techniques in other European countries which have traditionally been more successful in this area than the UK.



## Part 2: Building Engineering Physics – teaching case studies

### Introduction

The field of building engineering physics encompasses a wide range of interdependent technical disciplines. The Visiting Professors have each taken a different approach to teaching building engineering physics, building services or environmental design with their host universities. The activities range from the provision of specialist units within general engineering degree courses to the design of an entirely new undergraduate course. In this section of the report each of the participating universities has submitted a case study setting out its programme for their visiting professor and showcasing elements of student work that demonstrate the success of their approach.



**An interdisciplinary project critique: Students present their design solutions to a panel of architects, structural and environmental engineers.**  
Courtesy University of Bath

### University of Sheffield, Department of Civil and Structural Engineering

The Department of Civil and Structural Engineering has used the appointment of Bernard Johnston, Founding Partner of multidisciplinary engineering practice Cundall Johnston and Partners LLP to establish an undergraduate MEng programme that blends building services, structural engineering and architecture within the context of sustainable, low energy building design.

The new MEng in Architectural Engineering Design combines input from the departments of Civil and Structural Engineering, Mechanical Engineering, Mathematics and the School of Architecture. Modules are delivered by academics and visiting practitioner tutors exposing students to an exciting mix of theory, practical application, design and research developments.

Entry is either direct at first year or by transfer from other associated courses at second year. The course is about to enter its third year of enrolment and has achieved provisional accreditation by the Joint Board of Moderators and the Institution of Mechanical Engineers. The first students will graduate from the course in June 2011.

To provide a contextual setting for the diverse subject matter of the programme a new module, Tectonics, has been developed and presented by the Visiting Professor in the second year. Its aims are to describe the principal

drivers of building design and their relationship to societal demands. It provides an appreciation of the system behaviour of fabric, services and structure in common building types and their impact on occupant response, architectural form, thermal performance, day-lighting and energy efficiency.

The module is assessed through an individual project demonstrating understanding of tectonics in building design and a critique of an existing building. The critique concentrates on the choice of tectonic systems, their technical characteristics, integration with structure and building services and their influence on overall building performance. Students are encouraged to offer alternative solutions and excellent work has been produced, as illustrated by this extract from a report on the Innovate Green Office in Leeds by Liz Ward, a second year Architectural Engineering Design student.

The appointment of the Visiting Professor and the consequent development of the MEng programme as a result of The Royal Academy of Engineering initiative have accelerated the department's longer term aim to establish a centre of excellence encompassing teaching at graduate and postgraduate level and high quality research into the application of low carbon concepts in the building industry. A fundamental requirement in achieving that goal is to ensure the integration of the inspiration generated by internationally recognised research with the quality of teaching needed to produce 'best in class' engineers for industry.

The University has approved the establishment of a postgraduate taught MSc programme in the subject and have provided the funding for initially one academic post with further appointments as the programme grows. Aware of the need to broaden the intake base, the course has been designed to appeal to a wide range of undergraduate and postgraduate disciplines and to encourage those taking it to continue in the field after graduation. The development of this MSc programme is opportune as the University of Sheffield has recently been awarded an Engineering and Physical Sciences Research Council grant to establish a Doctoral Training Centre for research in energy generation and use (E-Futures) bringing together energy related research from the engineering, science and humanities faculties.

## Extract from Building Critique: Innovate Green Office

By Liz Ward

### Proposal for alternative façade system

A proposal for the façade would be to add a secondary space, as demonstrated in the diagrams. This would capture heat from the early morning sun, which could be utilized to heat the office space. The original façade could be retained behind this additional space allowing occupants to open their own windows to control natural ventilation into the building.

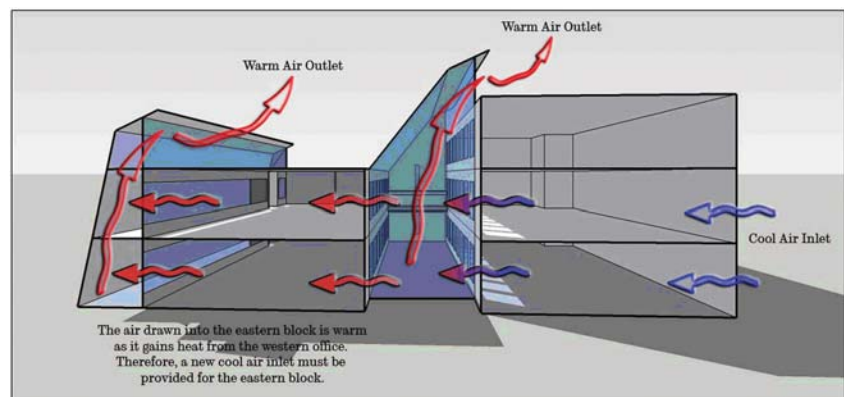

#### Possible air flow paths with additional façade

Clear glazing allows for the greatest solar gains, however this is likely to lead to overheating in the new space, which in turn would lead to overheating in the office spaces. This could be mitigated by adding shades, as in the existing atrium, however, positioning these on the inside of the glass is inefficient since these do not prevent heat entering the space. It may, therefore, be more suitable to use coated or coloured glass, which would reduce the solar gain, but would also reduce the likelihood of overheating, as seen in Jessop West, Sheffield. Defining it as an unoccupied space, with access only required for maintenance, would reduce the impact of any overheating and would, in effect, create a twin-skin façade, proven to be very effective in providing passive ventilation.

If this new space was configured in a similar way to the existing atrium, with exhaust louvres above the height of the building, it is likely that this new space would increase the effectiveness of the stack ventilation. However, since this space would encase the eastern block, the air drawn into the eastern offices is likely to be air from the western block, which would not be as cool as desired. Therefore, there should also be provision for a cool air inlet to the eastern block; which would be achieved by adding openable windows to the northern façade or by integrating inlet vents, at ground level, to the secondary façade.

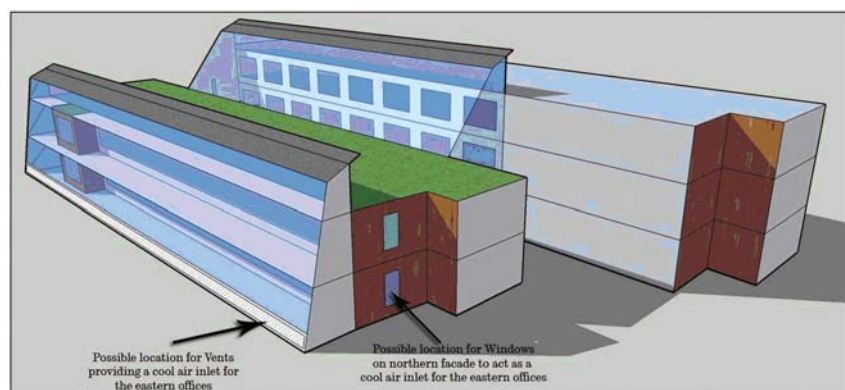

#### Locations for windows or vents to provide a cool air inlet

### University of Bath, Department of Architecture and Civil Engineering

The Department of Architecture and Civil Engineering at the University of Bath is founded on the premise that good building design is the result of the effective collaboration between Architectural and Engineering disciplines. It has been a guiding principal that the students should be taught together since the department was established in 1965.

The department is using the appointment of Doug King, Founder of King Shaw Associates, as Royal Academy of Engineering Visiting Professor to transform the teaching of environmental design throughout the undergraduate architectural and civil engineering courses. Professor King is developing a strand of building engineering physics, building services and environmental design teaching that will weave its way throughout the undergraduate curriculum.

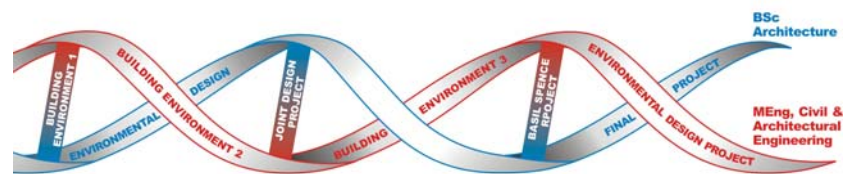

This approach uses a commonly taught Building Environment course in the first year of study to introduce building engineering physics and environmental design as a series of themes including comfort, thermal, light and energy for example, which are developed throughout the remainder of the courses with a slightly different focus for each strand appropriate to architects and engineers. Both the architects and engineers begin their final year studies with a joint design project in which teams of students work together to design a major public building. The project is also a competition, with authors of the winning scheme receiving the Department's principal academic award, the Basil Spence Prize.

The project has always been designed to present construction challenges to test the collaborative skills of the architects and engineers; but over the past few years, with the involvement of Professor King, the project has included challenging environmental design issues to bring out the students' abilities to apply building physics principals to design problems. Examples of recent project briefs have included the British Pavilion for the 2010 Expo in Shanghai, which involved both the students and the tutors trying to get to grips with designing for extremely high occupation densities in a tropical climate, and a low energy hotel adjacent to the runway at Bristol Airport.

In 2008/09 the project set was the redevelopment of Birnbeck Island, an outcrop in the Bristol Channel off Weston-Super-Mare, connected to the mainland by a derelict pier. The brief required a major public building or tourist attraction and a ferry terminal for services to South Wales. The site presented a number of difficult challenges, not least the extremely limited access and the harsh marine environment.

These design challenges resulted in some genuinely innovative design solutions. An example of one of these innovations is a variable façade system designed to moderate solar gains and maximise the potential for daylight. Given the aggressive nature of the local environment the students went on to design a passively activated automatic solar shading device as the key component of their dynamic façade system.



## Extract from Project Report: Birnbeck Island Concert Hall

### Dynamic façade system

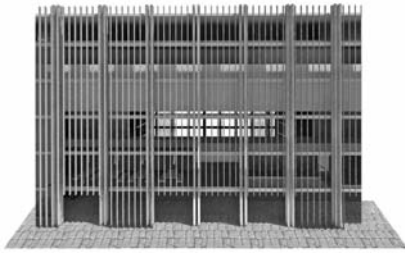

10:00 Fins in open position

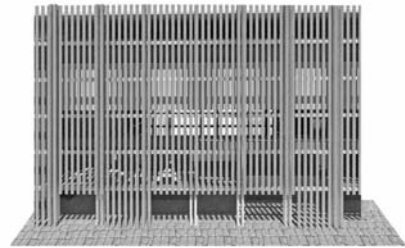

13:00 Fins providing 80%

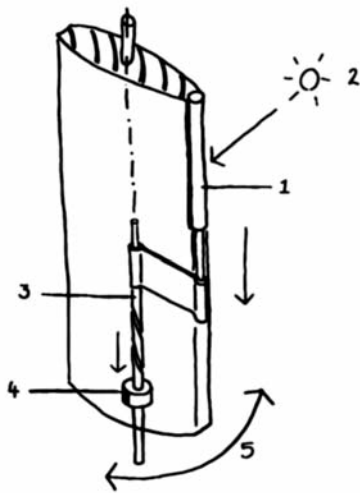

There are two types of dynamic façade system: electronically operated and manually operated. Both these solutions come with inherent problems. Systems driven by computer software and electronic components are infamous for their poor reliability and software glitches. They are very expensive to install and to repair. Manually operated systems need human intervention to operate and therefore need a strict management procedure in place for them to work effectively. Often these systems are left unused and therefore a much cheaper fixed shading system may as well have been installed.

With these problems in mind, we decided to take a new approach to solar shading and design a passive system, operated by the sun and free from any electronic or human intervention. The system uses the heat from the sun to convert an expansion force into a rotational one. When the sun is incident on the fin's leading edge a thermo-hydraulic element heats up, rotating the fin and shading the building. Once the sun has passed, the system cools and the fin reopens. The system will be configured so that during the winter, when external temperature is low, the system will not heat up sufficiently to rotate. This means that the building can benefit from the gains of the sun to aid heating during cold periods.

The marine environment is a hazardous place for moving components due to the salt content in the air. For this reason we have designed our shading system in such a way that moving parts are inside the depth of the fin and are therefore protected from the elements.

A hydraulic arm (1) filled with a wax that expands when exposed to the sun's heat (2), is attached to a rod with a helical thread (3). When the wax expands the hydraulic arm creates a linear motion. The helical thread passes linearly through a fixed nut (4), which creates a rotational force, (5)

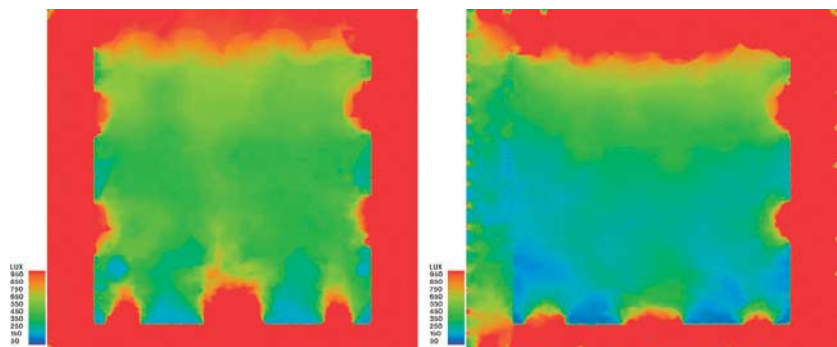

Plans showing lighting levels with the dynamic façade system. Left shows the condition with fins open and right shows the condition when the fins on the west side of the hall are closed.

### University of Cambridge, Department of Engineering

The Engineering Department at the University of Cambridge received funding from The Royal Academy of Engineering in 2006 for the appointment of Randall Thomas, a senior partner at Max Fordham as Visiting Professor in Building Engineering Physics in order to expand and deepen the existing teaching in building engineering physics by introducing current experience of construction and consultancy.

One of the most important aspects of the initiative has been to update the Building Physics module and totally revise the Architectural Engineering module. This approach illustrates a Cambridge view that building engineering physics is both a theoretical subject and a design discipline.

The building physics course is designed primarily for fourth year engineering students following a programme leading to an MEng in Engineering. It also attracts students studying for an MPhil in Architecture or MPhil in Engineering from the Centre for Sustainable Development and even a few PhD students. The Architectural Engineering module is primarily for the same fourth year engineers and, in addition, for third year architects. It too appeals to students from the same Masters Degree programmes, reflecting the genuinely interdisciplinary approach that has been adopted.

The aim of the Architectural Engineering module is to introduce the students to a holistic approach to design which combines engineering rigour with a functional and aesthetic understanding of architecture. Students use both design and analytical skills to develop non-standard innovative design ideas as workable prototypes for buildings. The module is organized around a design project. Students work on projects as teams, each consisting of a mix of students from architecture and engineering. Students are encouraged to design imaginatively with few pragmatic constraints such as cost and feasibility for example. One reason for this is to make the course interesting and exciting and so encourage engineering students to enter the field of building engineering physics.

Contact teaching sessions consist of short lectures, presentations by outside speakers and workshops for design development with a total of about five teachers available for the class. This fairly high teacher to student ratio reflects a commitment on the part of both departments to ensure that the course is successful and becomes established as a key element in the teaching of sustainable design.

During the academic year 2008/09 the project was to design a solar house for Cambridge that consumes no fossil-fuel energy. A floor area of 70m<sup>2</sup> was specified but students were free to choose the site. A comfortable internal environment was a key criterion.

There was a range of responses with both urban and suburban sites being chosen, with emphasis being placed to varying degrees on energy conservation or on renewable energy production, with some projects concentrating more on appearance and some more on engineering and so forth. This diversity is welcomed as it indicates that the students feel fairly unconstrained.

The Algae House project is representative of the high quality work produced in the course. It responded perfectly to the aim of integrating architecture, engineering and biology for the 21<sup>st</sup> Century built environment. It involved detailed technical analysis and this science and engineering informed the architectural design. The project won the CIB (International Council for Building) student competition at the June 2009 SASBE (Smart and Sustainable Built Environments) conference in Delft. The competition judges commended the entry for its multidisciplinary team approach with work by architects, engineers and bio-scientists.

### Extract from Project Report: The Algae House

**By Chris Bowler, Karuga Koinange, Daniels Krug, Ben Sheppard and Oliver Hudson.**

Algae are fast becoming the preferred source of bio-mass for use in the production of bio-diesel. Unlike conventional means of processing biomass crops however, a far cleaner, greener method is possible by way of hydrogen production. In the absence of sulphur they will switch from the production of oxygen as in normal photosynthesis, to the production of hydrogen. Capture of hydrogen, used in conjunction with a fuel cell, opens up the potential for a totally CO<sub>2</sub> free route to end-use consumption of energy.

From early on in the design development it became clear that certain environmental constraints on successful cultivation were analogous to those required by humans. The potential existed for the algae and domestic spaces of our 'Algae House' to enter a symbiotic relationship, whereby the one promoted the optimum environmental conditions for the other and vice versa. This close relationship is even evident in the waste water recycling system whereby filtered brown water provides vital nutrients for the algae to grow.

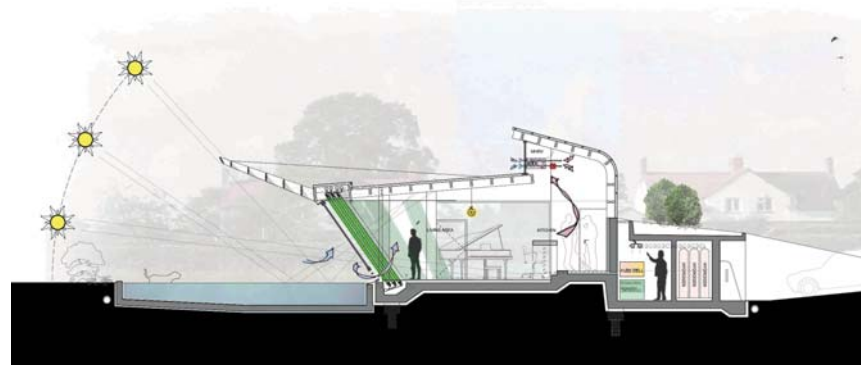

The form of the façade was developed to achieve maximum insulation, whilst maintaining a stable temperature, so optimising the production of hydrogen. Through careful consideration of the algae tubes' altitude and azimuth orientation to the sun, and working in combination with a fixed louvre system, direct solar heat gain is allowed only during winter months and on spring and autumn mornings and evenings – heat is stored in the concrete floor slab and internal concrete low level wall. The external pool reflects low angle sun up to the algae façade, whilst absorbing more of the higher energy high angle mid-day summer sun.

Based on the assumption that current trends in the genetic modification of algae continue towards the anticipated level of 15% efficiency in the conversion of light energy to hydrogen, the house is estimated to produce 4100kWh per annum – enough to cover all energy demands of the occupants.

Algae and people may not present themselves as obvious bedfellows, but through this project we hope to have shown that the integration of algae as an energy generator within a house is not only feasible, but that co-habitation can result in a self-sustainable symbiotic system and open up many exciting architectural possibilities for 'green living'.

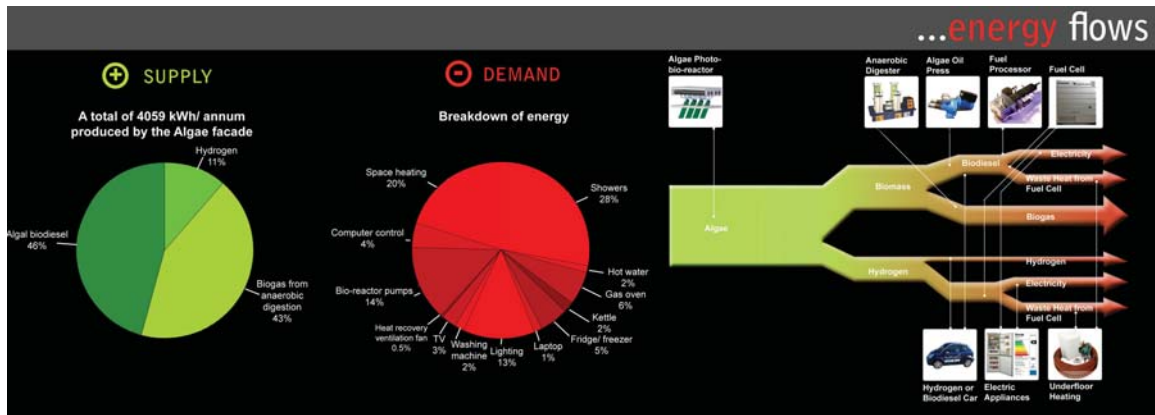

### University of Bristol, Faculty of Engineering

With the funding from The Royal Academy of Engineering Visiting Professor scheme, the University of Bristol has appointed Peter Bull of Arup as a Visiting Industrial Professor of Building Engineering Systems in the Faculty of Engineering. Through this appointment the University is delivering a coherent programme of taught units in *Engineering for the Built Environment* aimed at all engineering undergraduates at the University.

To deliver a new specialisation the Faculty, with the assistance of Professor Bull, has developed an optional programme of two teaching units entitled *Engineering for the Built Environment*. The units are delivered in years three and four of the MEng programmes. The units are designed to be delivered sequentially with the first covering aspects of human comfort and performance, sustainable development and an introduction to building services systems. The second unit examines individual building services systems in more detail. The first unit can be taken in the third or fourth year, whilst the second unit is only available for the fourth year.

The Engineering for the Built Environment units are available as options on the civil, mechanical, electrical and aeronautical engineering, engineering design, engineering mathematics and computer science programmes. Students from other faculties (e.g. physics) may also opt for the units, as open university units, if they have the required pre-requisites.

The programme is integrated with the teaching of design and systems engineering across the faculty particularly through project work. An experience-lead teaching approach is adopted, led by Professor Bull. Each year a design project is identified to form the basis of an assignment which is aimed at delivery of a conceptual design report in the first unit and detailed design in the second. Last year the project was for the design of a modular building system that would provide self-sufficient and sustainable teaching accommodation, deployed to charities, in the event of a crisis. The crisis location is deliberately set in an extreme environment, in this case Trondheim in Norway. The students are asked to identify sustainability objectives and responses to the local constraints. The concept report includes a systematic comparison between the proposed design and a 'business as usual alternative'; this is used to encourage the inclusion of features that will improve sustainability.

During the concept design process, a poster summarising design principles and features is presented and this early stage output is used to check progress and provide feedback.

### Extract from Concept Design Report: Modular School for Trondheim

By Tone Fallan Smaavik

We believe there is a market for modular building systems being provided to local charities in the event of crises. Such a system would be self-sufficient and sustainable teaching accommodation fit to be constructed quickly and cost effectively and in various locations. As a relatively temporary structure suitable for a wide range of events, the modular building should only make minimum demands on local supply to contribute to heating, cooling and water services. The objective of this report is to analyse an extreme northern latitude location, Trondheim, Norway, to identify design criteria and sustainable options that will provide the best end product.

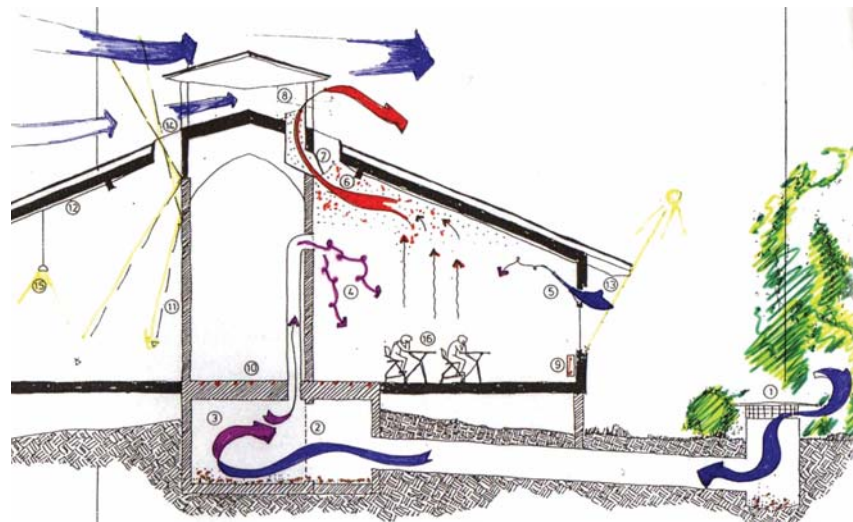

## Passive techniques to minimise energy and water consumption

Measure	Explabtion	Comments
Insulation to Norwegian Standards	Ensures use of local knowledge to suit climate	
Triple glazed windows	Prevents drafts and minimises heat loss through windows	
Building materials of high thermal mass	Prevents fluctuating indoor temperature and minimises heat loss	Some materials of high thermal mass often take a lot of energy to produce
Insulating pipes	Minimises heat loss and gain for hot and cold pipes	Coloured insulation creates educational aspect
Orientation of windows and light shafts	Natural day lighting reduces need for artificial lighting.	Glazing improves wellbeing of occupants and creates an in-door-outdoor connection
Natural ventilation	Openable windows, chimney for stack effect, underground culvert air inlet	
Controlled heating	A thermostat ensures that heating is efficient and stays at a set temperature	Can be regulated as conditions change throughout the year
Motion sensors, water taps	Reduces water consumption as taps turn off automatically	
Spray taps	Can reduce water and energy used by 80% compared to normal taps	
Urinals	Waterless urinals do not require water supplies	Cheap to install, no risk of flooding or frost damage
Dual flush or low flush toilets	Reduces water consumption from 6l to 4.5l or less per flushing	Educational as dual flush raises awareness of water consumption
Rainwater harvesting	Collected rainwater can be used for flushing toilets, reducing demand on local water supply	Most effective for buildings with large roofs. Does require storage tanks and treatment
Greywater collection	Water collected from washbasins can be used for flushing toilets	Minimal treatment necessary if water is not stored for long
Low wattage light bulbs	Reduces energy usage	Will contribute less to heating of room
Motion sensors, lights	Reduces energy usage on unnecessary lighting	
Avoid door sensors	No energy required for normal doors.	Doors for disabled access can be opened by switches
External blinds	Used on south facing windows to pre-vent overheating in summer	
Planting trees	Deciduous trees provide shading in the summer and will allow for solar heat gain in the winter	More relevant for permanent structure
Location of structure	Nearby buildings and trees can provide protection from wind, thereby reducing heat loss and draughts	





## Part 3: Building Engineering Physics – practice case studies

### Introduction

The Visiting Professors have been drawn from a wide range of consultancy backgrounds, from the very largest organisations to some of the smallest, from international multidisciplinary practices to specialists. Nevertheless each of the practices that have provided a visiting professor for the scheme is committed to developing sustainable building practices.

The case studies in this section of the report have been submitted by the Visiting Professors' practices to demonstrate the application of building engineering physics to the design of buildings. The buildings showcased here cover the entire spectrum from commercial through education to leisure.

Two of the projects: the Innovate Green Office and the BRE Environmental Building demonstrate the range of solutions appropriate to reducing energy demands in mass market commercial buildings to a level that would be sustainable with renewable energy. The other two projects: The Eden Court Arts Centre and the Bristol Schools PFI demonstrate the use of building engineering physics to solve particular performance aspects of the design.



**The Visiting Professors in Building Engineering Physics, from left to right: Doug King, King Shaw Associates; Bernard Johnston, Cundall Johnston & Partners LLP; Peter Bull, Arup; Randall Thomas, Max Fordham LLP.**



### The BRE Environmental Building

The brief for the Environmental Building was drawn from a Building Research Establishment (BRE) publication *The Energy Efficient Office of the Future*<sup>(2,3)</sup>. In addition to using the latest innovations in energy efficient design the brief called for a landmark building with the highest architectural standards. The building also needed to achieve an Excellent BREEAM rating, act as a test bed for research and demonstrate techniques which could be adopted in the design of future commercial offices.

The building is situated on the BRE's campus about 15 km northwest of London with surrounding buildings varying from one to six stories or so. To the south there is an open space of about 30m providing ample opportunity for the use of solar energy. This open space, and the low noise levels at the building envelope of about 45-55dBA also facilitated natural ventilation.

The design was based on holistic conceptions and takes advantage of all available local sources of energy. The site sits above a chalk aquifer which underlies a large part of southern and eastern England. A borehole of 70m depth into the aquifer was used as the source of water for a low energy cooling system. The building was designed to accommodate solar energy (thermal and photovoltaic panels) on the roof. In the event PV panels were installed in a less efficient but more visible position on the south facing façade.

In addition the building went beyond simple energy conservation to incorporate a philosophy of material use and construction and deconstruction techniques, pioneering the use of reclaimed brick bonded with lime mortar for future reclamation.

### Key features

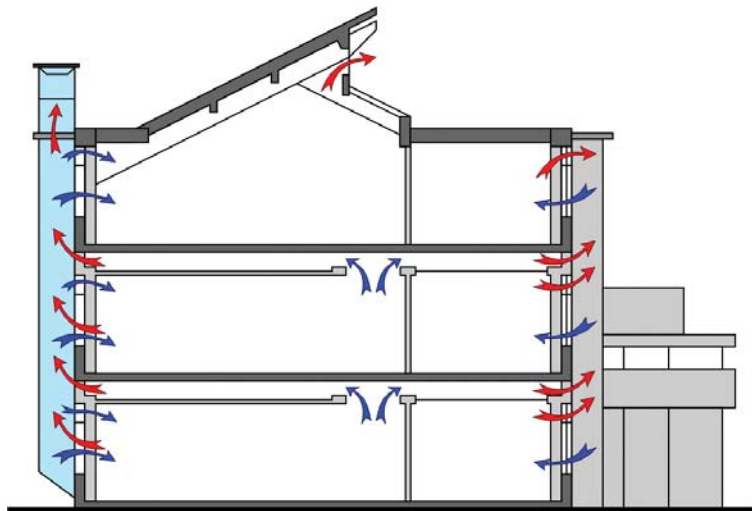

The building was designed for natural ventilation and high levels of daylight. The daylight strategy is an exercise in optimisation. On the south façade movable glass louvers with a white ceramic coating giving a light transmission of 40% and a reflectance of 50% provided a reasonable balance among solar gain, daylight and glare control.

An innovative sinusoidal high thermal mass concrete floor slab was used to deliver pre-cooled or pre-heated fresh air to the office spaces. The form of the slab also added visual interest on both the ground and first floors making the



spaces virtually unique in UK office design. Air enters at high level from the perimeter, travels through the slab, drops in the corridor and then rises out through stacks on the south facade or windows on the north facade.

Procurement by two-stage tender meant that the contractor was available early in the process to advise on buildability and value engineering, whilst the extensive knowledge of the client informed the design and construction process. Perhaps because of the high profile nature of the project, an exceptional degree of good will prevailed and cooperation was constant.

### Outcome

The result of the design and construction collaboration was a highly efficient and comfortable landmark building. The project achieved 39 out of 42 credits under BREEAM 1/90 New Offices<sup>(24)</sup>. Post occupancy monitoring showed that summertime temperatures in the offices were often 6-9°C lower than outside making the building a magnet for those seeking a moment of relief from the heat. This was achieved without reliance on the borehole cooling system which was only needed at peak times for the seminar facilities.

Initially, energy consumption was somewhat higher than predicted due principally to infiltration heat losses and higher computer loads. With time and sealing of the building the actual performance has come closer to the initial estimates.

The environmental office has become the benchmark for low energy naturally ventilated offices. The building received widespread publicity and helped to encourage the move towards a more sustainable architecture. As one of the headlines of the time read, 'It's green and it works'. This building gave a powerful message to the construction community.

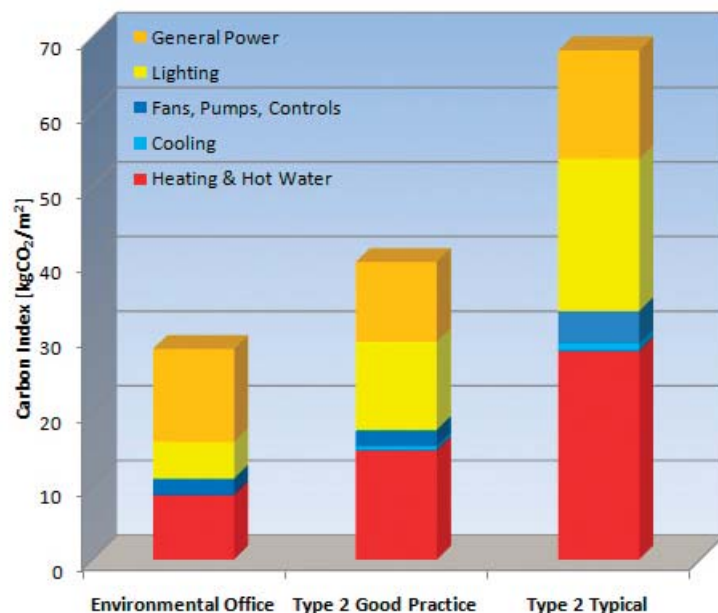

Carbon Emissions from the Environmental Office compared with ECG19 National Benchmarks<sup>(25)</sup>



### Eden Court Arts Centre

Originally opened in 1976 and incorporating the Grade A listed Bishops Palace, the original residence of the Bishop of Inverness, the Eden Court Arts Centre plays a pivotal role in the cultural life of Inverness and the Highlands and Islands. In recent years it had become clear that the centre's existing accommodation needed to be refurbished and extended in order to provide for a broader range of cultural activities and expand its conference facilities.

The Bishop's Palace and original theatre were retained and two new extensions added to create: the One Touch Theatre, two cinemas, two studios for dance and drama, new offices and dressing rooms. The existing accommodation was refurbished with essential disabled access provision, new café, bars, restaurant, box office, shop, toilets and meeting rooms.

The new spaces have been designed to be naturally ventilated, which has greatly influenced the architecture of the new extension which includes six large ventilation towers, boldly clad in black, blue and polished stainless steel to a design by artist Donald Urquhart. The asymmetry of the new extension and the design of the tall ventilation towers echo the form of the original Bishop's Palace.

#### Key features

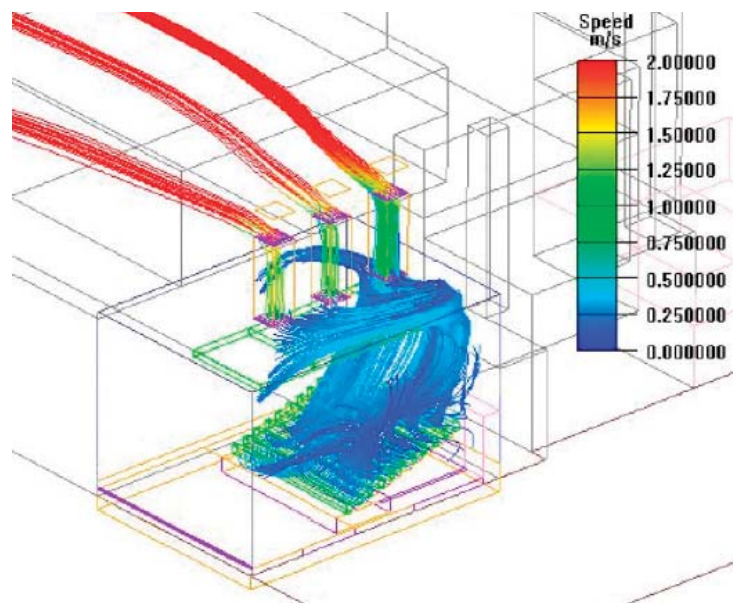

Detailed analysis of the building was carried out using dynamic thermal simulation software to establish accurate thermal load profiles in order to optimise the efficiency of the heating and ventilation equipment. Subsequently, the analysis model and calculated loads were used in a computational fluid dynamics, (CFD) analysis to establish the required dimensions for the natural ventilation chimneys and the effectiveness of the strategy in maintaining both air quality levels and temperature within the One Touch Theatre and cinema auditoria.

A detailed study of the prevailing wind conditions on the site was included in the CFD analysis, taking into account the effects of adjacent buildings, to ensure an accurate portrayal of real site conditions as they would impact on the performance of the natural ventilation system. The supply air terminals are discreetly located under the theatre seating working in conjunction with the

high-level natural ventilation exhausts to provide displacement ventilation. Low energy plate fans are located within the natural ventilation chimneys to assist with the exhaust air process in periods of warm still weather when the natural stack effect alone may not be effective.

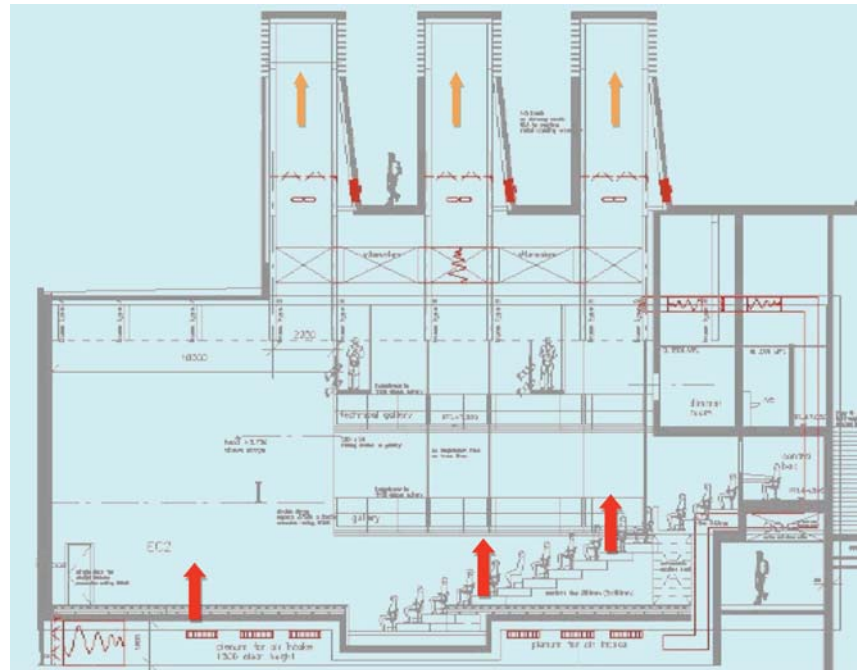

### Outcome

The project demonstrates the successful application of passive ventilation strategies and modelling techniques to the environmental challenges associated with the intermittent heavy occupancy, high heat loads, sedentary nature of the occupants and the high air change rates needed in theatres and cinemas.

The completed building, which opened in March 2008, has been performing well and internal comfort levels within the building are reported to be very good by staff and visitors alike.

### The Innovate Green Office



The Green Office was commissioned by developer Innovate to demonstrate a step change in commercial office design, significantly reducing resource consumption and carbon emissions. The building achieved the highest BREEAM score to date, despite being located on a greenfield site with poor transportation links. The success of the project stems from the attention to resource conservation throughout the design and construction.

The early engagement of the environmental engineer allowed the building to be designed from first principles with every aspect being assessed for its contribution to the overall environmental performance. This engineering led exercise produced an optimum solution for environmental performance, rather than taking the approach of bolting renewable energy technologies onto a conventional building design.

The building is mechanically ventilated and comfort cooled, yet has energy consumption equivalent to good practice naturally ventilated offices. A vacuum drainage system uses harvested rainwater for the toilet flushing to virtually eliminate the use of treated mains water to convey sewage, whilst the overall volume of sewage discharged from the building is reduced by about three quarters.

#### Key features

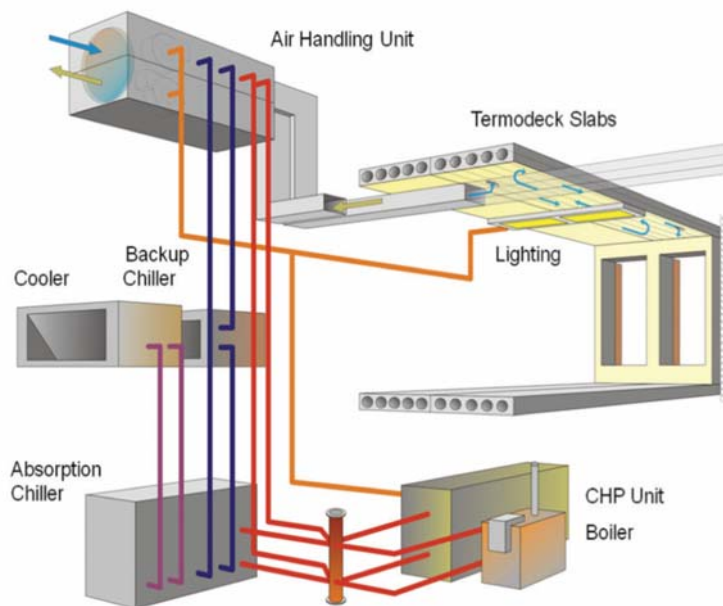

The building was designed to passive solar principles with high thermal mass, super insulation and daylight. The whole building is designed as a thermal energy store. The structure uses pre-cast panels of re-cycled concrete for the walls and roof, externally insulated, substantially exceeding the requirements of the Building Regulations at  $0.15\text{W/m}^2\text{C}$ , and exposed internally giving high thermal mass. The floor and roof slabs are used as Termodeck to further increase the thermal mass. Heating, cooling and electricity tri-generation is provided by a 30kW baseload CHP and matched absorption chiller.

With the insulation levels achieved, the heat loss is reduced to a point where the internal gains provide the majority of useful heat. Thermal wheels in the air handling units deliver excess heat onto the fresh air supply. Supply air is routed via the Termodeck where its temperature is regulated by giving up excess heat

to the thermal mass or absorbing additional heat from it. In this way the casual heat gains in the building are recovered and stored for later beneficial re-use, rather than simply being rejected to atmosphere.



The building is cooled using similar principles: The ventilation runs overnight with outdoor air to draw out any excess heat stored in the thermal mass. During the day warm fresh air is cooled in the Termodeck lowering the supply temperature. In the peak summer condition the gains may exceed the capacity of the building to passively reject heat and the chiller is energised. However, the thermal mass is again essential as the installed chiller capacity is less than half of the peak cooling load. A predictive control algorithm runs the chiller overnight to store additional cooling in the thermal mass in a strategy akin to ice storage. Thus the chiller runs continuously at full load for extended periods, the ideal scenario for utilising heat from the CHP.

### Outcome

The carbon emissions from the building services installations are some 80% less than previous office buildings by Innovate, saving over 350 tonnes of CO<sub>2</sub> per year. The reduction in energy and water consumption represents a saving of about £1.50 per square foot each year. When compared to the expected rental yield of £12-15 per square foot the energy savings will make a significant contribution to business profitability.

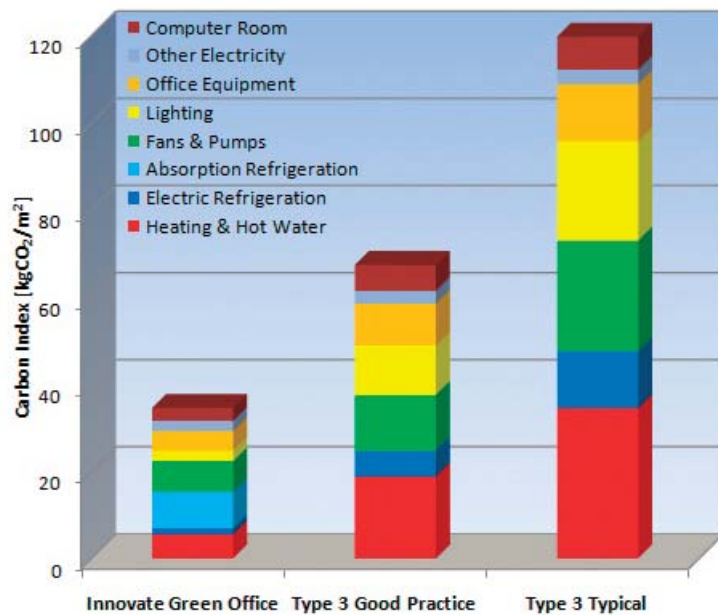

Predicted Carbon Emissions from the Green Office compared with ECG19 National benchmarks<sup>(25)</sup>

### Bristol Schools PFI



Many of the UK's secondary schools will be either rebuilt or refurbished in the next decade. This presents the industry with a significant opportunity to not only deliver low energy buildings, but also to demonstrate building physics to a new generation of potential engineers. The Bristol Schools PFI comprised four new schools; Henbury, Portway, Bedminster and Monks Park, in locations throughout Bristol.

The common environmental strategy for the new schools relied heavily on passive thermal and natural ventilation techniques to minimise energy consumption and maximise thermal comfort. Overheating and poor ventilation are major contributors to a poor learning experience and it was recognised that the role of the engineer was critical to deliver an excellent internal environment in an affordable manner.

The passive strategy was established early in the design and was enthusiastically incorporated in subsequent detailed proposals drawn up by the Architects and the Contractor. The strategy relies on the teachers controlling the classroom environment and this presented the engineers with an opportunity to speak to staff to explain the design concept and how to make the most of the buildings. These discussions also highlighted the importance of building physics and the purpose behind the very visible features in the spaces. This knowledge enables the teachers to discuss the merits of the passive design solution with the students, in support of the curriculum.

#### Key features

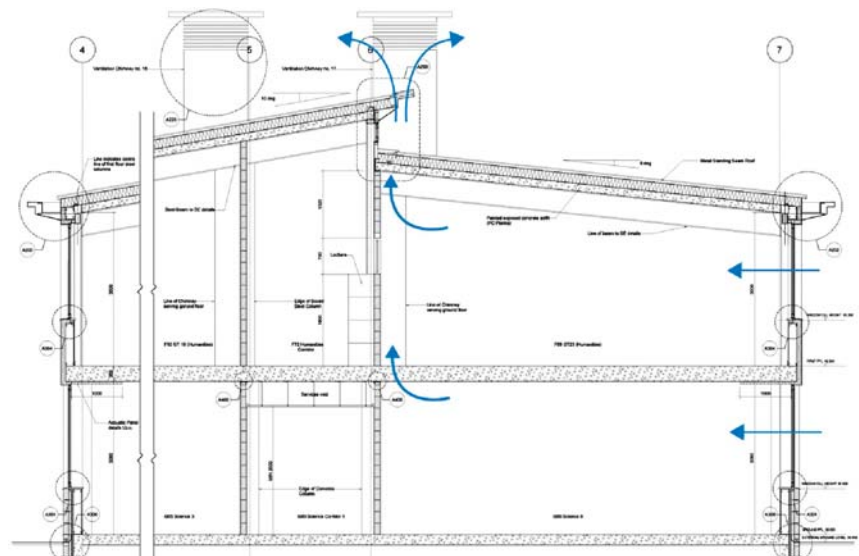

The buildings had to be simple robust and easy to use, making the most of opportunities for passive conditioning and avoiding expensive and complicated mechanical control systems.

The solution was a simple one: intelligent window design with a stack chimney, making the most of both the available wind and buoyancy pressures. This provides good cross ventilation of spaces under a wide range of weather



conditions. The windows were provided with two opening parts, the main window for use in the summer for high ventilation rates and a small hopper window for trickle ventilation in the winter and as a secure ventilator for overnight purging to discharge excess heat. The use of opening windows also permitted simple user control of temperature and ventilation rates.

Exposed concrete at ceiling level, on all floors, presented the requisite thermal inertia to moderate temperature rise in the classrooms. The concrete absorbs excess heat during the daytime and can be discharged by ventilating with cool fresh air at night.

A critical component of the control system is the occupants; their behaviour affects the performance of the space. Windows are manually controlled and are, generally, the only source of fresh air including during the winter. Thus the engagement of the staff with the design team throughout the process was critical to the success of the schools.

### **Outcome**

The end result are popular and flexible teaching spaces with the hoped for outcome of improved educational outcome evidenced by improved exam results.

Latest indication for the schools is that fossil fuel consumption is around 100kWh/m<sup>2</sup> annually, which is within the lower quartile of DFES benchmarks for maintained schools<sup>(26)</sup>. Electricity consumption meanwhile is high, approaching 90th percentile. This reflects greater electricity consumption associated with ICT usage.

It is reported that comfort levels within the naturally ventilated schools are high. In other words, the beneficial passive elements deal with high internal gains.



## References

1. CIBSE, 2004. *Weather Data with Climate Change Scenarios*, TM34. Chartered Institute of Building Services Engineers
2. Aleklett K, Campbell C, 2003. *The Peak and Decline of World Oil & Gas Production*. Minerals & Energy 18 2003
3. Gilbert R, Perl A, 2008. *Transport revolutions – how to fuel transport once oil supplies dwindle*. Energy World 360, May 2008, Energy Institute
4. DCLG, 2007. *Building a Greener Future - Policy Statement*. Department of Communities & Local Government
5. DCLG, 2009. *Proposals for amending Part L and Part F of the Building Regulations*, Consultation Document. Department of Communities & Local Government
6. DCLG 2006. *Approved Document L2A: Conservation of fuel and power (New buildings other than dwellings)*. Department of Communities & Local Government
7. EU, 2002. *Directive 2002/91/EC Of The European Parliament And Of The Council Of 16 December 2002 On The Energy Performance Of Buildings*
8. NAO, 2007. *Building for the future: Sustainable construction and refurbishment on the government estate*. National Audit Office
9. Davis Langdon, 2004. *Examining the Cost of Green*. [www.davislangdon.com](http://www.davislangdon.com)
10. EEBPP, 1999. *A Quantity Surveyor's Guide to the Cost-Effectiveness of Energy-Efficient Offices*, GPG274. Energy Efficiency Best Practice Programme.
11. CIBSE, 2009. *Educational base for Chartered Engineer Registration – M22*. Chartered Institute of Building Services Engineers
12. JBM, 2009. JBM151 Accredited Degrees CEng. Joint Board of Moderators
13. Nethercot D, Lloyd Smith D, 2001. *Attracting the best and brightest: Broadening the appeal of engineering education*. The Ove Arup Foundation
14. ACE, 2009. *ACE Agreements, Schedule of Services*. Association for Consultancy and Engineering
15. RIBA, 1999. *Standard form of Appointment for an Architect SFA/99*. Royal Institute of British Architects
16. CIC, 2004. *Built Environment Professional Services Skills Survey 2003/2004*. Construction Industry Council
17. Ruyssevelt P, Bordass W, Bunn R, 1995. *Probe - Post-occupancy review of building engineering*, Building Services Journal, July 1995
18. Prof Michael Kelly, Chief Scientist for CLG, speaking at Energy in Transition Conference. Reported in Energy World 373 July/August 2009, pp17
19. Jenkins A, 1995. *The Research Assessment Exercise, funding and teaching quality*. Quality Assurance in Education Vol3, No2, pp4-12
20. ECUK, 2003. *UK Standard for Professional Engineering Competence*. The Engineering Council
21. RAEng, 2007. *Educating Engineers for the 21<sup>st</sup> Century*, The Royal Academy of Engineering

22. TSB, 2009. *Design & Decision Tools for Low Impact Buildings, Competition for Funding*. Technology Strategy Board June 2009
23. BRECSU, 1995. *General Information Report 30: A Performance specification for the energy efficient office of the future*, Building Research Energy Conservation Support Unit
24. Baldwin R et al, 1990. *BREEAM 1/90: An Environmental Assessment for New Office Designs*, Building Research Establishment
25. EEBPP, 2000. *Energy Consumption Guide 19, Energy Use In Offices*, Building Research Energy Conservation Support Unit
26. DFES, 2002. *Energy and Water Benchmarks for Maintained Schools in England: 2000-01. Bulletin 11/02*. Now published by Department for Business Innovation and Skills

# The Royal Academy of Engineering

As Britain's national academy for engineering, we bring together the country's most eminent engineers from all disciplines to promote excellence in the science, art and practice of engineering. Our strategic priorities are to enhance the UK's engineering capabilities, to celebrate excellence and inspire the next generation, and to lead debate by guiding informed thinking and influencing public policy.

The Academy's work programmes are driven by three strategic priorities, each of which provides a key contribution to a strong and vibrant engineering sector and to the health and wealth of society.

## Enhancing national capabilities

As a priority, we encourage, support and facilitate links between academia and industry. Through targeted national and international programmes, we enhance – and reflect abroad – the UK's performance in the application of science, technology transfer, and the promotion and exploitation of innovation. We support high quality engineering research, encourage an interdisciplinary ethos, facilitate international exchange and provide a means of determining and disseminating best practice. In particular, our activities focus on complex and multidisciplinary areas of rapid development.

## Recognising excellence and inspiring the next generation

Excellence breeds excellence. We celebrate engineering excellence and use it to inspire, support and challenge tomorrow's engineering leaders. We focus our initiatives to develop excellence and, through creative and collaborative activity, we demonstrate to the young, and those who influence them, the relevance of engineering to society.

## Leading debate

Using the leadership and expertise of our Fellowship, we guide informed thinking, influence public policy making, provide a forum for the mutual exchange of ideas, and pursue effective engagement with society on matters within our competence. The Academy advocates progressive, forward-looking solutions based on impartial advice and quality foundations, and works to enhance appreciation of the positive role of engineering and its contribution to the economic strength of the nation.

 Please recycle this brochure (the cover is treated with a recyclable laminate)



The Royal Academy of Engineering promotes excellence in the science, art and practice of engineering.

Registered charity number 293074

The Royal Academy of Engineering  
3 Carlton House Terrace, London SW1Y 5DG

Tel: 020 7766 0600 Fax: 020 7930 1549  
[www.raeng.org.uk](http://www.raeng.org.uk)